



APPROVED BY

Director of Development
TMK – Premium Services LLC



29 april 2016

**Guidelines
For Use of Casing
With Thread Connection TMK UP PF with GW Compound**

RE PS 05-003-2015

Revision 3

CHECKED BY

Head of Experimental Design Bureau
TMK – Premium Services LLC



29 april 2016

DEVELOPED BY

Head of Serial Design Bureau
TMK – Premium Services LLC

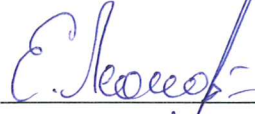

28 april 2016

2016

Contents

Introduction.....	3
1 Scope.....	4
2 Normative references	4
3 Terms and definition.....	4
4 Transportation, handling operations and storage	5
4.1 Transportation.....	5
4.2 Handling operations.....	6
4.3 Stockholding and storage.....	7
5 Preparation of pipes for make-up.....	8
5.1 General provisions.....	8
5.2 Visual inspection	8
5.3 Thread protectors removal	9
5.4 Thread connection inspection	9
5.5 Drifting.....	10
5.6 Measurement of length of pipes	11
5.7 Installation of thread protectors	11
6 Make-up of pipes	12
6.1 Running and Pulling	12
6.2 Assembly of string	13
6.3 Make-up inspection	18
6.4 Break-out of string	25
7 Manufacturer's warranty.....	26
Attachment (mandatory) Equipment for make-up registration	27
Attachment B (mandatory) Types of damages and methods of repair	28
Attachment C (recommended) Thread compound application	31

Introduction

The present guidelines are worked out taking into account the requirements of the following documents:

- API RP 5C1 Recommended Practice for Care and Use of Casing and Tubing;
- API RP 5 1 Gaging and Inspection of Casing, Tubing and Pipe Line Threads;
- ISO 10405 Petroleum and Natural Gas Industries – Care and Use of Casing and Tubing.
- TR CU 010/2011 – Technical Regulations of EAEC “on the Safety of Machinery and Equipment”.

Guidelines for use of casing with thread connection UP F with GW
Compound

Effective date: April 11, 2016

1 Scope

The present guidelines contain recommendations for maintenance and use of casing with TMK UP F thread connection with GW compound under field conditions, including pipe preparation and make-up, string running and pulling operations, as well as guidelines for pipe handling, storage and inspection during operation.

2 Normative references

The present guidelines refer to the following documents:

API RP 5A3/ISO 13678 Recommended Practice on Thread Compounds for Casing, Tubing, and Line Pipe;

TU 0254-001-46977243-02 RUSMA-1 Thread Compound;

TU 0254-031-46977243-04 RUSMA R-4 Thread Compound'

TU 0254-068-46977243-2011 RUSMA -14i Thread Compound;

TU 0254-102-46977243-2011 RUSMA SP Thread Compound;

N O T E: The specified document revision shall be applied for dated references. The latest valid revision shall be applied for undated references

3 Terms and definitions

For the purposes of these guidelines standard terms shall apply as well as the following terms with the corresponding definitions:

3.1 metal-to-metal seal: Seal or sealing system that relies on intimate and usually high contact stress of a metal surface to achieve a seal.

3.2 rotation on shoulder: Excessive turns after shoulder to ensure thread connection tightness.

3.3 **pin (pin connection):** A threaded connection on Oil Country Tubular Goods (OCTG) that has external (male) threads and/or seal, shoulder.

3.4 **box (box connection):** A threaded connection on Oil Country Tubular Goods (OCTG) that has internal (female) threads and/or seal, shoulder.

3.5 **thread seals:** Box seal and pin seal.

3.6 **thread shoulders:** Pin shoulder and box shoulder.

3.7 **pin shoulder:** Pin face which serves as an arrester during make-up.

3.8 **box shoulder:** Internal barrier which serves as an arrester during make-up.

3.9 **pin seal:** Area of the pin external surface which provides for tightness of the thread connection during make-up.

3.10 **box seal:** Area of the box internal surface which provides for tightness of the thread connection during make-up.

3.11 **GW:** Greenwell compound.

4 Transportation, handling operations and storage

4.1 Transportation

4.1.1 When pipes are transported by sea, railroad (railcars) or trucks, Cargo Shipping Rules and Technical Provisions for Cargo Handling and Fastening applicable to the particular transport type shall be observed.

4.1.2 Pipe transportation, handling and storage shall be carried out with thread protectors screwed on pipe and coupling end-faces in order to protect thread surface, thread shoulders and thread seals from exposure.

4.1.3 Pipe bundles of different lots and standard sizes can be loaded into same means of transportation, but have to be separated.

4.1.4 Pipe bundles shall be securely fastened during transportation to avoid any movement. Wooden blocks can be used for fastening purposes.

When several pipes bundles are stacked or not bundled pipes are stacked into several ranks, pipe bundles and pipe ranks shall be separated by at least three wooden blocks, with the thickness

from 1,3780 – 1,5748 inch each, so that weight of upper pipe ranks is not distributed onto couplings of lower ranks.

4.1.5 When transported by sea, pipe bundles shall not be placed in water inside the vessel's hold or in any other corrosive environment. Dragging of bundles along the piles or hitting bundles against hatches or rails is strictly forbidden.

4.1.6 When loading pipe bundles into railway cars or trucks, wooden girders (blocks) shall be provided for car floors or vehicle beds to ensure required distance between the products and uneven bottom of the vehicle. No blocks shall be placed under couplings.

4.2 Handling operations

4.2.1 All handling operations with pipes shall be carried out with thread protectors screwed on pipe and couplings ends.

4.2.2 Handling operations with pipe bundles shall be carried out only with the help of hoisting transportation clamps.

In case of manual unloading, rope slings shall be used and pipes shall be rolled along guides in parallel to the pile, avoiding quick movement and collision of pipe ends that might result in pipe and coupling thread damage even with protectors in place.

When using the crane, spreader beams with slings shall be used according to approved slinging diagrams.

4.2.3 Pipes shall not be allowed to fall down from heights or be picked up by the upper pipe end in a bundle with a hook or be dragged or subjected to any other actions that might damage pipe and coupling threads, surfaces or shapes.

4.2.4 Handling operations with chromium steel pipes shall be performed using nylon or steel slings with plastic braid. When using forklift, gripping forks, frames and clamps with nonmetallic coating shall be employed.

4.2.5 Handling operations for chromium steel pipes shall exclude collision with hard bodies having sharp edges that can result in sufficient local increase of pipe surfaces hardness and affect the sulfide stress cracking resistance.

4.3 Stockholding and storage

4.3.1 Pipe storage conditions shall comply with GOST 15150 for Group 4 (storage period: 2 years). If storage of pipes is more than 2 years represervation shall be performed with preservative compound (like «Kendex OCTG» or equivalent) or preservative thread compound.

4.3.2 Pipes stockholding shall be performed in compliance with Materials, Equipment and Spare Parts Stockholding and Storage Guidelines at production and technical maintenance facilities ensuring their preservation and avoiding damage of pipe and coupling threads, surfaces or shapes.

4.3.3 Pipe bundles shall be stacked on supports spaced in a manner avoiding sagging or thread damage. Rack supports shall be located in one plane and shall not sag under pile weight. Rack bearing surface shall be minimum 11,8110 inch above the ground or floor.

Pipe bundles shall not be stocked on the ground, rails, steel or concrete floor!

It shall be no stones, sand, dirt on racks!

4.3.4 When several pipe bundles are stacked into a pile or not bundled pipes are stacked into several ranks, pipe bundles and pipe ranks shall be separated by at least three wooden blocks, with the thickness from 1,3780 – 1,5748 inch each, so that weight of upper pipe ranks is not distributed onto couplings of lower ranks.

The height of the pipe pile shall not exceed 9,8425 ft.

4.3.5 Stockholding of unbundled pipes is allowed provided vertical posts are installed in the racks.

4.3.6 If pipes are rolled on the racks, any movements at an angle to the rack axis shall be excluded as that may result in collision of pipe ends and damage of thread or thread protectors.

4.3.7 During pipe storage availability and integrity of thread protectors, as well as compound underneath. Pipe corrosion shall not be allowed.

4.3.8 Pipes damaged during transportation, rejected during inspection, prepared for repair or awaiting a final decision shall be stored on separate racks with the corresponding tags.

4.3.9 During chromium steel pipes storage, wood or plastic gaskets shall be placed onto all pipe supports.

4.3.10 Drilling site shall have special area for pipe stockholding in compliance with above-listed requirements.

4.3.11 Required quantity of racks shall be installed at drilling site in order to provide for stockholding of full set of pipes.

While stacking onto racks it is important to consider the order of string running (if it is specified in the work instruction) to be sure that the first pipe according to the work plan is not under the pipes that shall be run later. Pipes shall be placed onto racks in such a way as to ensure couplings are facing the wellhead.

5 Preparation of pipes for make-up

5.1 General provisions

Prior to lifting the pipes onto the rig site, proceed as follows:

- perform visual inspection of pipes and couplings;
- remove thread protectors from pipes and couplings;
- inspect pipe and coupling surfaces of thread connections
- drift pipes along the entire length
- measure the length of each pipe
- re-install clean thread protectors on pipes and couplings

5.2 Visual inspection

Visual inspection of pipes, couplings and thread protectors shall be performed in order to detect bent pipes, dents and damages.

Visual inspection of pipes and couplings shall be carried out with protectors screwed on.

Pipes, couplings, thread protectors with significant damages, discovered during visual inspection shall be put aside awaiting decision on their suitability for use.

Amount of damaged pipes shall be specified in the Product Quality Non-conformity Protocol and all damaged areas shall be documented on photographs.

5.3 Thread protectors removal

Thread protectors shall be removed after thread connections are visually inspected.

Thread protectors shall be removed manually or using a special tong with one person effort. In case of difficulties when removing thread protectors heating of thread protectors with steam is allowed or striking slightly with a wooden hammer at a protector's end to eliminate a possible distortion.

5.4 Thread connection inspection

Thread connection shall be inspected by the following specialists:

- crews for casing strings assembly;
- companies specialized in casing inspection.

When running casing for the first time, representatives of the casing supplier shall be present.

Examples of thread connection exterior view with GW compound on pin and coupling are given in Figures 1 and 2.

When inspecting pin and coupling connections, including thread surface, thread seals and shoulders make sure you pay due attention to the following:

- Mechanical damages;
- Corrosion or other chemical damages caused as a result of environmental;

Types and methods of damages repair are specified in Attachment B.

Under low light condition (twilight, night) individual portable light source shall be used during inspection.

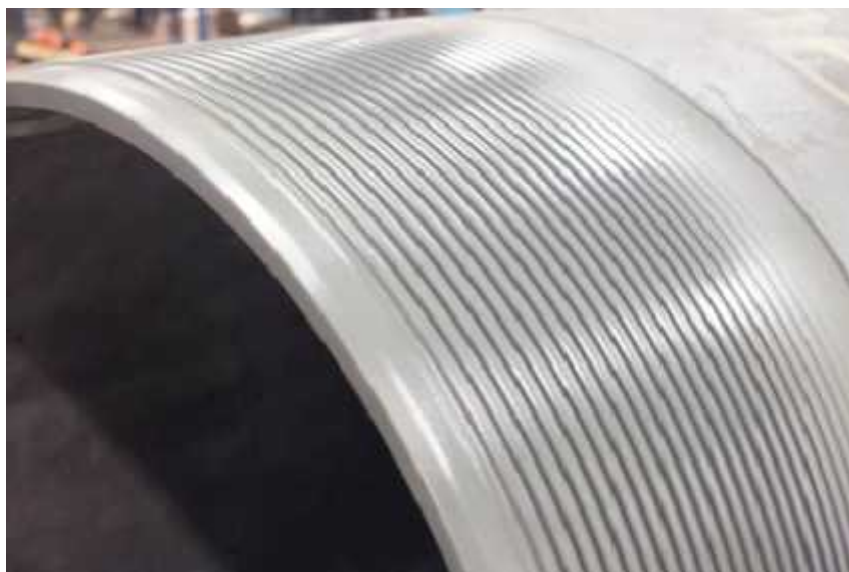

Figure 1 – Pin



Figure 2 - Coupling

5.5 Drifting

Pipe should be checked by drift along the entire length of the pipe. For pipes made of chromium and corrosion-resistant steels polymer or aluminium drifts shall be used.

Before drifting, the pipe shall be positioned in such a manner as to avoid sagging. If any ropes or bars are used for the drifting process, they shall be clean. In case of freezing temperatures pipes shall be heated prior to drifting, to remove snow and ice crust.

Pipe and drift shall be of the same temperature during drifting process.

Dimensions of the drift effective part shall comply with those specified in Table 1. Diameter of the effective part of the drift shall be checked in three planes along the entire length after each 50 pipes check. If the diameter decreases by more than 0,0197 inch in any of the three planes, such a drift shall be rejected.

The drift shall pass through the entire pipe, when pulled manually without significant effort.

If the drift cannot pass through the pipe, such a pipe shall be replaced with another pipe and shall be specified in the product quality non-conformity protocol.

Pipes rejected during drifting process, shall be put aside until further decision on its validity.

Table 1 – Effective dimensions of the drift

Pipe outside diameter, inch	Effective length of the drift inch	Diameter of the effective part of the drift, inch
up to 8 5/8 incl.	5,9843	d – 0,1252
9 5/8 –13 5/8	12,0079	d – 0,1563
NOTES - d – is a nominal pipe inside diameter		

5.6 Measurement of length of pipes

Length of each pipe shall be measured from free (without a thread protector) coupling end to free (without thread protector) pipe end.

It is recommended to compare measured pipe length with the marked length. In case of discrepancies the measured length shall be marked on pipe body with a marker or chalk

When calculating the total length of the string, one should use the formula specified below:

$$L = L - n L \quad (1)$$

where: L – the total length of the string;

L – overall length of pipes in a string, measured from pin end face to free coupling end face;

n – number of pipes in a string;

L – decrease of length of pipes during make-up (see Table 2).

Table 2 – Decreasing of pipe length during make-up process**In inches**

Pipe outside diameter, inch	Decrease of pipe length during make-up L , inch
4 1/2	4,0787
5	4,2008
5 1/2	4,2638
6 5/8	4,4843
7	4,6732
7 5/8	4,9134
7 3/4	4,9134
8 5/8	5,0394
9 5/6	5,1024
9 7/8	5,1024
10 3/4	5,1417
11 3/4	5,1417
11 7/8	5,1417
12 3/4	5,1417
13 3/8	5,1417
13 5/8	5,1417

5.7 Installation of thread protectors

Upon performance of inspection and control, thread protectors or protective caps shall be re-installed on pipe and couplings ends.

Prior to installation thread protectors shall be thoroughly cleaned and shall not have considerable damages, affecting protection of thread and thread seals from direct environmental impact.

6 Make-up of pipes

6.1 Running and Pulling

6.1.1 Casing shall be assembled by a qualified operator. To ensure declared operational features of thread connection, make-up shall be performed with make-up torque registration system applicable;

If make-up torque registration system is not available then the following shall be used in priority-oriented order:

- Manometer of breakout tong (conversion of pressure into torque in compliance with the tong manufacturer recommendations);

- Make-up triangle (transverse stripe) it.6.3.2.

6.1.2 A special bell guide is recommended for running and pulling operations (Figure 3). The devices help to align pin and coupling and prevent the connection from damage.

6.1.3 In order to decrease probability of new damages during running and pulling operations, it is recommended to use pipe weight balancer.

6.1.4 While running string of chrome steel pipes one should better use elevator or special wedge claws to avoid pipe body damages.



Figure 3 – Make-up with special bell guide

6.1.5 Rotary tongs shall be equipped with a speed governor and ensure speed of 2 rpm at the final stage of make-up.

Tongs shall be equipped with clamps for specific pipe sizes to ensure a larger contact area with the pipe body. Clamp diameter shall be 1 % greater than pipe nominal diameter. Clamps shall be adjusted in such a way that they hold the pipe tightly and never slip.

For make-up and break-out chromium steel pipes, the rotary tongs shall be equipped with non-metal or non-injurious tong dies.

Prior to make-up, tongs shall be positioned as per Figure 4.

6.1.6 Make-up equipment shall ensure torque at least 30% greater than recommended maximum make-up torque. Breaking-off requires higher torque than make-up.

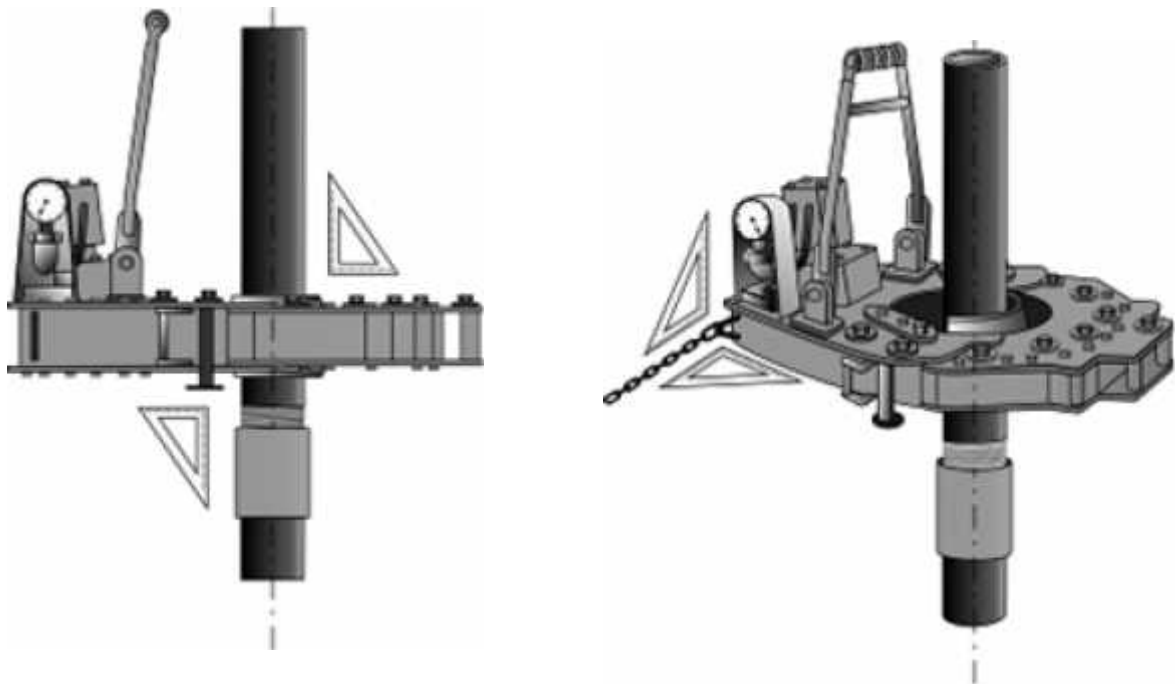

Figure 4 –Rotary tongs positioning before make-up

6.2 Assembly of string

6.2.1 Make sure thread protectors are secured in place prior to lifting pipes on to the rig floor.

Lifting pipes to the rig floor without thread protectors or end caps is not allowed!

6.2.2 Prior to assembly of the string remove thread protectors and check by touch surfaces of thread seals and thread shoulders of the free pipe end for any mechanical damage, check for alignment of the assembled pipes (Figures 5 and 6).

6.2.3 Prior to make-up it is recommended to perform air blasting of pipe and coupling, make sure that surfaces of thread, thread seals and thread shoulders with applied compound are free from mud or mud laden fluid with small contaminations, hindering tightness of connection. In case of mud or mud laden fluid on connection surfaces, you shall remove it from connection surfaces.

6.2.4. In case of combined assembly (one end of thread connection with GW compound is made-up with the other end of thread connection without compound), thread compound shall be applied in accordance with Attachment B.



Figure 5 – Mechanical damage inspection

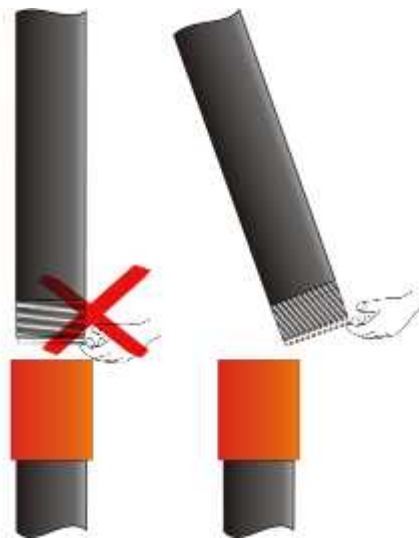

Figure 6 – Alignment inspection

6.2.4 When stabbing pipe into coupling, pipe face end shall not hit coupling face end, pin sliding down into the coupling end, when pipe face end contacts coupling face end is not allowed.

6.2.5 Make-up shall be performed with the torque specified in Table 3.

In case make-up of the connection with torque within the ranges, specified in Table 3 does not comply with the settled requirements, M_{opt} can be corrected but maximum $\pm 10\%$. Herewith the values of M_{min} and M_{max} shall also be corrected, but maximum $\pm 10\%$ from the corrected M_{opt} .

Table 3 – Make-up torques

D, inch	S, inch	Torque, ft. lb. for steel grades																										
		J55, K55			N80, L80			90			R95, 95,T95			110, 110			Q125			Q135			TMK140			TMK150		
		min	opt	max	min	opt	max	min	opt	max	min	opt	max	min	opt	max	min	opt	max	min	opt	max	min	opt	max	min	opt	max
4 1/2	0,2500	2700	3000	3300	3500	3900	4300	3800	4300	4700	4000	4400	4900	4400	4800	5300	4800	5300	5800	5200	5800	6300	5500	6000	6600	5600	6200	6800
	0,2902	3200	3500	3900	4100	4500	4900	4500	5000	5500	4600	5200	5700	5000	5600	6200	5600	6200	6800	6000	6600	7300	6300	7000	7700	6500	7200	8000
	0,3370	3400	3800	4100	4400	4900	5500	4900	5500	6000	5000	5600	6200	5500	6100	6700	6100	6800	7400	6500	7200	8000	6900	7700	8400	7200	8000	8800
5	0,2961	3500	3900	4300	4400	4900	5400	4700	5200	5800	4700	5200	5800	5300	5900	6500	5800	6500	7200	6400	7200	7900	6700	7500	8300	7000	7800	8700
	0,3618	4400	4800	5300	5400	6000	6600	5800	6400	7100	5800	6400	7100	6500	7200	8000	7200	8000	8800	7900	8800	9700	8300	9300	10200	8700	9600	10500
	0,4370	4900	5500	6000	6200	6900	7500	7000	7800	8600	7000	7800	8600	7700	8600	9500	8700	9700	10600	9100	10100	11100	9600	10600	11700	10000	11100	12100
	0,4780	5400	6000	6600	6800	7500	8300	7700	8600	9400	7700	8600	9400	8500	9400	10400	9500	10500	11600	10000	11100	12200	10500	11700	12800	10900	12100	13300
	0,5000	5700	6300	6900	7100	7900	8700	8000	8900	9800	8000	8900	9800	8900	9900	10800	10000	11100	12200	10400	11600	12800	11000	12200	13500	11400	12700	14000
5 1/2	0,2748	3700	4100	4600	4600	5100	5600	5100	5700	6300	5100	5700	6300	5700	6300	7000	6300	7000	7700	6700	7400	8200	7100	7900	8700	7400	8200	9000
	0,3039	4100	4600	5000	5000	5600	6200	5700	6300	6900	5700	6300	6900	6300	7000	7700	7000	7700	8600	7400	8300	9100	7700	8700	9600	8000	9000	10000
	0,3610	4700	5200	5800	5500	6100	6700	6300	6900	7600	6300	6900	7600	7300	8100	8900	8100	9000	9900	8100	9000	9900	8600	9500	10400	8900	9900	10800
	0,4150	5500	6000	6600	6300	7000	7700	7200	8000	8800	7200	8000	8800	8300	9300	10300	9300	10300	11400	9300	10300	11400	9800	10800	12000	10200	11300	12500
	0,4760	6300	6900	7600	7200	8000	8800	8300	9100	10000	8300	9100	10000	9700	10700	11800	10700	11900	13100	10700	11900	13100	11200	12500	13700	11700	13000	14300
6 5/8	0,2882	6100	6800	7400	7400	8200	9000	8300	9300	10300	8300	9300	10300	9400	10500	11500	10300	11500	12700	10800	12000	13200	11400	12700	13900	11900	13200	14500
	0,3150	7200	8000	8800	8100	9700	10800	10000	11100	12200	10000	11100	12200	11300	12900	13800	12400	13800	15200	12900	14300	15700	13700	15200	16800	14200	15800	17500
	0,3520	7400	8300	9100	9000	10000	11000	10300	11400	12500	10300	11400	12500	11500	12800	14000	12600	14000	15400	13100	14600	16100	13900	15400	17000	14500	16000	17700
	0,4169	8800	9800	10800	10600	11800	13000	12100	13400	14700	12100	13400	14700	13600	15100	16700	15000	16600	18300	15600	17300	19100	16400	18300	20100	17100	19000	20900
	0,4748	10000	11100	12200	12100	13400	14700	13700	15300	16800	13700	15300	16800	15500	17200	18900	17000	18900	20800	17800	19800	21800	18700	20800	22900	19500	21600	23700
7	0,3169	6300	7100	7800	8300	9100	10000	9100	10200	11200	9100	10200	11200	10100	11200	12300	11300	12500	13800	12100	13400	14700	12800	14200	15600	13300	14700	16200
	0,3618	7300	8100	8900	9400	10400	11400	10400	11600	12800	10400	11600	12800	11500	12800	14000	12800	14200	15600	13700	15300	16800	14500	16200	17700	15000	16700	18400
	0,4079	8300	9100	10000	10500	11700	12900	11700	13100	14400	11700	13100	14400	13000	14400	15900	14500	16100	17700	15600	17300	19000	16400	18100	20000	17000	18900	20800
	0,4531	9100	10200	11200	11800	13100	14500	13100	14600	16100	13100	14600	16100	14500	16100	17700	16200	17900	19700	17400	19300	21200	18300	20400	22400	19000	21200	23300
	0,4980	10100	11200	12300	13000	14500	15900	14500	16100	17700	14500	16100	17700	15900	17700	19500	17700	19700	21700	19100	21200	23400	20100	22400	24700	20900	23300	25700
	0,5402	11900	13200	14500	14700	16300	17900	16300	18100	19900	16300	18100	19900	18400	20500	22600	20500	22800	25100	21600	24000	27700	22600	25100	27700	23500	26100	28700
	0,6252	14000	15600	17100	17300	19200	21200	19200	21400	23500	19200	21300	23500	21800	24300	26700	24300	26900	29600	25500	28300	31100	26700	29600	32600	27700	30800	33900
0,6870	15600	17300	19100	19200	21400	23500	21400	23700	26100	21300	23700	26000	24300	26900	29600	26900	29900	33000	28200	31400	34600	29600	32900	36200	30800	34200	37600	
7 5/8	0,3280	9000	10000	11100	10700	11900	13100	12100	13400	14700	12100	13400	14700	13000	14500	15900	14200	15700	17300	15700	17500	19200	16600	18400	20200	17200	19100	21000
	0,3748	10800	12000	13200	13200	14700	16200	15100	16800	18500	15100	16800	18500	17000	18800	20700	18300	20300	22300	19500	21600	23700	20400	22700	25000	21200	23600	26000
	0,4299	12400	13800	15200	15100	16800	18500	17300	19200	21200	17300	19200	21200	19500	21600	23700	20900	23300	25700	22300	24700	27200	23500	26000	28700	24300	27100	29800
	0,5000	14400	16000	17600	17600	19500	21500	20200	22400	24600	20200	22400	24600	22600	25100	27600	24300	27100	29800	25900	28800	31600	27300	30300	33400	28400	31500	34700
	0,5618	16200	18000	19800	19800	22000	24200	22600	25100	27700	22600	25100	27700	25400	28200	31000	27400	30400	33400	29100	32300	35500	29900	33200	36500	29900	33200	36500
	0,5949	17900	19900	21900	22500	25000	27500	26100	29000	31900	26100	29000	31900	29900	33200	36500	29900	33200	36500	29900	33200	36500	29900	33200	36500	29900	33200	36500
7 3/4	0,5949	17800	19800	21800	22900	25400	28000	25500	28300	31100	25500	28300	31100	28100	31200	34300	29900	33200	36500	29900	33200	36500	29900	33200	36500	29900	33200	36500
8 5/8	0,3520	11600	12800	14100	13600	15100	16700	16800	18700	20500	16800	18700	20500	18300	20300	22300	19300	21500	23600	20000	22200	24400	21200	23500	25800	22000	24300	26800
	0,4000	13100	14500	16000	15500	17200	18900	18000	20000	22000	18000	20000	22000	20100	22300	24600	22100	24500	26900	22800	25300	27800	24000	26600	29300	24900	27700	30400
	0,4500	14700	16400	18000	17400	19300	21200	20300	22500	24800	20300	22500	24800	22600	25100	27700	24800	27500	30200	25600	28400	31300	27000	29900	32900	28000	31100	34200
	0,5000	16400	18200	20100	19400	21500	23700	22600	25100	27600	22600	25100	27600	25200	28000	30800	27600	30700	33800	28500	31600	34800	29900	33200	36500	29900	33200	36500
	0,5571	18300	20300	22300	21600	24000	26400	23700	26400	29100	23700	26400	29100	27300	30300	33300	29900	33200	36500	29900	33200	36500	29900	33200	36500	29900	33200	36500

Table 3 be continued

D, inch	S, inch	Torque, ft. lb. for steel grades																											
		J55, K55			N80, L80			90			R95, 95, T95			110, 110			Q125			Q135			TMK140			TMK150			
		min	opt	max	min	opt	max	min	opt	max	min	opt	max	min	opt	max	min	opt	max	min	opt	max	min	opt	max	min	opt	max	
9 5/8	0,3520	12100	13400	14700	14300	15900	17500	15800	17600	19300	15800	17600	19300	17000	18900	20800	18600	20600	22700	20900	23300	25700	22200	24600	27100	23000	25500	28200	
	0,3949	13700	15300	16800	16500	18400	20200	18400	20400	22500	18400	20400	22500	20300	22500	24800	22200	24600	27100	24300	27000	29700	25600	28500	31300	26600	29600	32500	
	0,4350	15300	17000	18700	18700	20800	22900	20900	23300	25700	20900	23300	25700	23600	26300	28900	25800	28700	31600	27600	30600	33700	29100	32200	35500	29900	33200	36500	
	0,4720	17000	19000	20900	21600	24000	26400	24600	27400	30100	24600	27400	30100	28900	32100	35300	29900	33200	36500	29900	33200	36500	29900	33200	36500	29900	33200	36500	
	0,5449	19700	21900	24100	24900	27700	30500	28500	31600	34800	28500	31600	34800	29900	33200	36500	29900	33200	36500	29900	33200	36500	29900	33200	36500	29900	33200	36500	
	0,5949	21500	23900	26300	27100	30200	33200	29900	33200	36500	29900	33200	36500	29900	33200	36500	29900	33200	36500	29900	33200	36500	29900	33200	36500	29900	33200	36500	
9 7/8	0,6252	29900	33200	36500	29900	33200	36500	29900	33200	36500	29900	33200	36500	29900	33200	36500	29900	33200	36500	29900	33200	36500	29900	33200	36500	29900	33200	36500	
	0,6610	29900	33200	36500	29900	33200	36500	29900	33200	36500	29900	33200	36500	29900	33200	36500	29900	33200	36500	29900	33200	36500	29900	33200	36500	29900	33200	36500	
	0,7201	29900	33200	36500	29900	33200	36500	29900	33200	36500	29900	33200	36500	29900	33200	36500	29900	33200	36500	29900	33200	36500	29900	33200	36500	29900	33200	36500	
10 3/4	0,3500	13600	15000	16500	17300	19200	21100	19500	21600	23700	19500	21600	23700	21300	23700	26000	24600	27300	30000	25400	28200	31000	26800	29700	32700	27800	30900	33900	
	0,4000	17300	19200	21100	21300	23700	26000	24600	27300	30000	24600	27300	30000	27400	30500	33500	29900	33200	36500	29900	33200	36500	29900	33200	36500	29900	33200	36500	
	0,4500	19500	21600	23700	24000	26600	29300	27600	30700	33800	27600	30700	33800	29900	33200	36500	29900	33200	36500	29900	33200	36500	29900	33200	36500	29900	33200	36500	
	0,4949	21400	23700	26100	26300	29300	32200	29900	33200	36500	29900	33200	36500	29900	33200	36500	29900	33200	36500	29900	33200	36500	29900	33200	36500	29900	33200	36500	
	0,5449	23500	26100	28700	29100	32300	35500	29900	33200	36500	29900	33200	36500	29900	33200	36500	29900	33200	36500	29900	33200	36500	29900	33200	36500	29900	33200	36500	
	0,5949	25700	28500	31400	29900	33200	36500	29900	33200	36500	29900	33200	36500	29900	33200	36500	29900	33200	36500	29900	33200	36500	29900	33200	36500	29900	33200	36500	
11 3/4	0,6720	29900	33200	36500	29900	33200	36500	29900	33200	36500	29900	33200	36500	29900	33200	36500	29900	33200	36500	29900	33200	36500	29900	33200	36500	29900	33200	36500	
	0,3331	18300	20400	22400	22300	24900	27400	23200	25800	28400	24300	27100	29800	26300	29300	32200	28000	31100	34200	28900	32100	35300	29200	32400	35700	29900	33200	36500	
	0,3748	19500	21600	23700	25100	27900	30700	26200	29100	31900	27000	30000	33000	29900	33200	36500	29900	33200	36500	29900	33200	36500	29900	33200	36500	29900	33200	36500	
	0,4350	22500	25000	27500	29000	32200	35500	29900	33200	36500	29900	33200	36500	29900	33200	36500	29900	33200	36500	29900	33200	36500	29900	33200	36500	29900	33200	36500	
	0,4890	25200	28000	30800	29900	33200	36500	29900	33200	36500	29900	33200	36500	29900	33200	36500	29900	33200	36500	29900	33200	36500	29900	33200	36500	29900	33200	36500	
	0,5339	27500	30500	33600	29900	33200	36500	29900	33200	36500	29900	33200	36500	29900	33200	36500	29900	33200	36500	29900	33200	36500	29900	33200	36500	29900	33200	36500	
11 7/8	0,5819	28200	31300	34500	29900	33200	36500	29900	33200	36500	29900	33200	36500	29900	33200	36500	29900	33200	36500	29900	33200	36500	29900	33200	36500	29900	33200	36500	
	0,5500	26900	29900	32900	29900	33200	36500	29900	33200	36500	29900	33200	36500	29900	33200	36500	29900	33200	36500	29900	33200	36500	29900	33200	36500	29900	33200	36500	
	0,5819	29900	33200	36500	29900	33200	36500	29900	33200	36500	29900	33200	36500	29900	33200	36500	29900	33200	36500	29900	33200	36500	29900	33200	36500	29900	33200	36500	
12 3/4	0,3740	17000	19000	20900	22000	24400	26800	25900	28800	31600	25900	28800	31600	28500	31600	34800	29900	33200	36500	29900	33200	36500	29900	33200	36500	29900	33200	36500	
	0,4331	19800	22000	24200	25400	28200	31000	29900	33200	36500	29900	33200	36500	29900	33200	36500	29900	33200	36500	29900	33200	36500	29900	33200	36500	29900	33200	36500	
	0,4882	22300	24700	27200	28700	31900	35000	29900	33200	36500	29900	33200	36500	29900	33200	36500	29900	33200	36500	29900	33200	36500	29900	33200	36500	29900	33200	36500	
	0,5512	25100	27900	30800	29900	33200	36500	29900	33200	36500	29900	33200	36500	29900	33200	36500	29900	33200	36500	29900	33200	36500	29900	33200	36500	29900	33200	36500	
13 3/8	0,3799	21000	23400	25700	27100	30100	33100	29900	33200	36500	29900	33200	36500	29900	33200	36500	29900	33200	36500	29900	33200	36500	29900	33200	36500	29900	33200	36500	
	0,4299	24900	27700	30500	29900	33200	36500	29900	33200	36500	29900	33200	36500	29900	33200	36500	29900	33200	36500	29900	33200	36500	29900	33200	36500	29900	33200	36500	
	0,4799	27800	30900	34000	29900	33200	36500	29900	33200	36500	29900	33200	36500	29900	33200	36500	29900	33200	36500	29900	33200	36500	29900	33200	36500	29900	33200	36500	
	0,5142	29900	33200	36500	29900	33200	36500	29900	33200	36500	29900	33200	36500	29900	33200	36500	29900	33200	36500	29900	33200	36500	29900	33200	36500	29900	33200	36500	
13 5/8	0,5551	29900	33200	36500	29900	33200	36500	29900	33200	36500	29900	33200	36500	29900	33200	36500	29900	33200	36500	29900	33200	36500	29900	33200	36500	29900	33200	36500	
	0,6252	29900	33200	36500	29900	33200	36500	29900	33200	36500	29900	33200	36500	29900	33200	36500	29900	33200	36500	29900	33200	36500	29900	33200	36500	29900	33200	36500	
	0,7598	29900	33200	36500	29900	33200	36500	29900	33200	36500	29900	33200	36500	29900	33200	36500	29900	33200	36500	29900	33200	36500	29900	33200	36500	29900	33200	36500	

NOTE: make-up with special couplings shall be performed using torque 20% less than the specified.

6.2.6 During make up of pipes and couplings made of steels of different grades, the make-up torque value shall be chosen according to the least grade.

6.2.7 The first two turns shall be carried out manually, or a strap tong can be used (Figure 7). Chain tong is allowed for use only under condition that the pipe body is secured from damage (e.g. safe gasket which is set between the pipe body and the tong).



Figure 7 – Make-up start with strap tongs

6.2.8 Make-up rotation speed during connection make-up with the rotary tong shall correspond to the values specified in Table 4.

Table 4 – Rotation speed during make-up

Start of make-up		End of make-up (rotation on shoulder)
First two turns of thread	Further turns of thread	
Speed maximum 2 rpm Better manually	Speed not more than 10 rpm	Speed maximum 2 rpm

6.2.9 Even longitudinal movement of the pipe resulting from gradual increase of number of engaged revolutions, shall be watched, significant warming of the connection (not more than 50° of the ambient temperature) shall not be allowed.

6.2.10 Make-up shall not cause significant mechanical damages like galling or jamming etc. on the pipe and coupling body.

The outer surface of coupling shall be free of damages with depth larger than 0.5% from the coupling nominal outside diameter.

Damages from tong clamps are allowed on the pipe outer surface under condition that the actual pipe wall thickness taking into account depth of the damage shall be not less than 87,5% from the nominal pipe wall thickness.

Upon make-up of chromium steel pipes the trace depth on the pipe body shall be not more than 0,0079 inch.

6.2.11 The final connection make-up torque shall be within the range from T_{min} to T_{max} .

6.2.12 When the maximum value of the final make-up torque (T_{max}) is achieved, turning of coupling from the side of mill connection is allowed, if the diagram is not changed during correct make-up (Figure 8). The final make-up torque values shall be within T_{min} to T_{opt} limits in order to reduce the probability of turning.

6.3 Make-up inspection

6.3.1 Make-up inspection by the make-up diagram.

6.3.1.1 If the make-up is performed correctly and all the thread connection geometric parameters comply with the requirements of the regulatory documentation, the make-up diagram will show defined areas, which correspond to torque increase due to thread surfaces mating (area I), and the further mating of thread seals and thread shoulders (area II and area III), as shown in the Figure 8 below.

The rotary torque increase on the first revolutions corresponding to the initial mating of thread surfaces shall be smooth and even. Further on, with mating of the thread surfaces and of thread seals, acceleration of rotary torque increase till shouldering of the connection shall take place. The shouldering shall be accompanied with the sharp increase in torque, which confirms that make-up is performed correctly.

Depending on the rotary tong used, and its adjustment, the make-up diagram (especially area I) can show areas with insignificant deviation from straight line: waves, leaps, etc. Such deviations shall be deemed acceptable if general view of the make-up diagram corresponds to the established requirements.

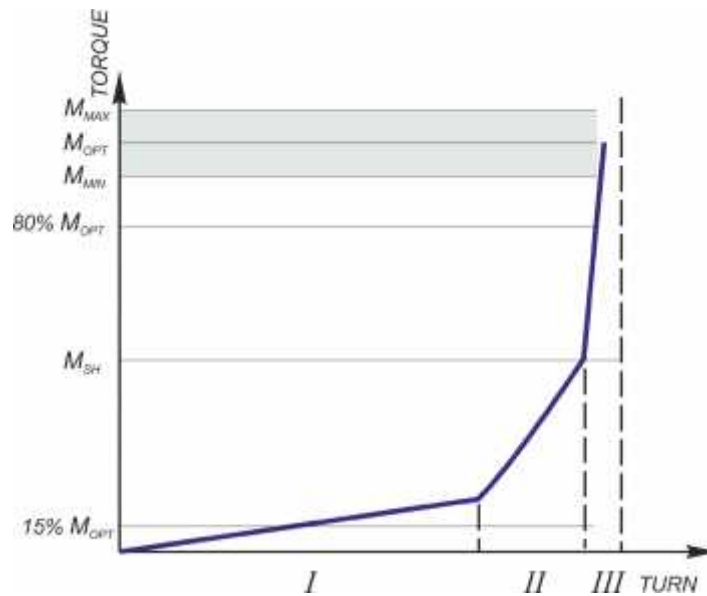

Figure 8 – Correct make-up diagram

6.3.1.2 The make-up diagrams for the pipes from the same lot shall be close in shape.

6.3.1.3 Shoulder torque M_{sh} of thread shoulders (box shoulder and pin shoulder) shall be within the range from 15 % and 80 % of optimum make-up torque M_{opt} .

6.3.1.4 Final make-up torque shall be within the range from minimum to maximum make-up torque.

6.3.1.5 Typical discrepancies of make-up diagram are specified in Figures 9 – 15.

6.3.1.6 If at the final step of make-up procedure torque increase stops and there appears a horizontal area (area IV Figure 9), but no slippage of clamp jaws is observed and the area IV length is maximum 0,12 of revolution, then such a make-up shall be considered acceptable. If not, the connection shall be broken-out, inspected for absence of damages and deformations. If during inspection of thread, thread seals and thread shoulders no surface damages are observed that can be repaired (Attachment B), re-assembly of the connection can be performed upon elimination of all the damages. If shape distortions, such as decrease of pin or box shoulder inside diameter, sagging on the coupling inside surface, or damages are observed, such pipes shall be replaced.

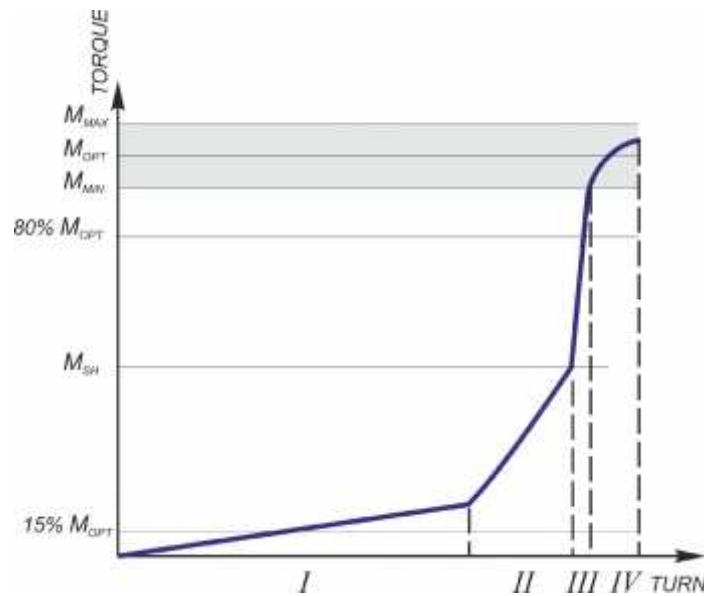

Figure 9 – Make-up diagram. Torque increase stopped in the area IV

6.3.1.7 If the diagram shows slight torque increase due to mating of thread seals (area II, Figure 10), this might be caused by insufficient contact of seal surfaces, or a combination of high thread interference and low seal interference.

If diagram shape is correct, one shall take into account, that a component of the radial seal on the make-up diagram is far less than a thread component. Therefore, it might not be always clear on the diagram, and the make-up can be deemed acceptable. Should any doubts arise in correctness of the make-up, the connection shall be broken-out, visually inspected and cleaned from compound if required. If during visual inspection the marks of contact are found on the surface of thread seals, then make-up shall be repeated, otherwise such a pipe shall be replaced and used during further make-ups.

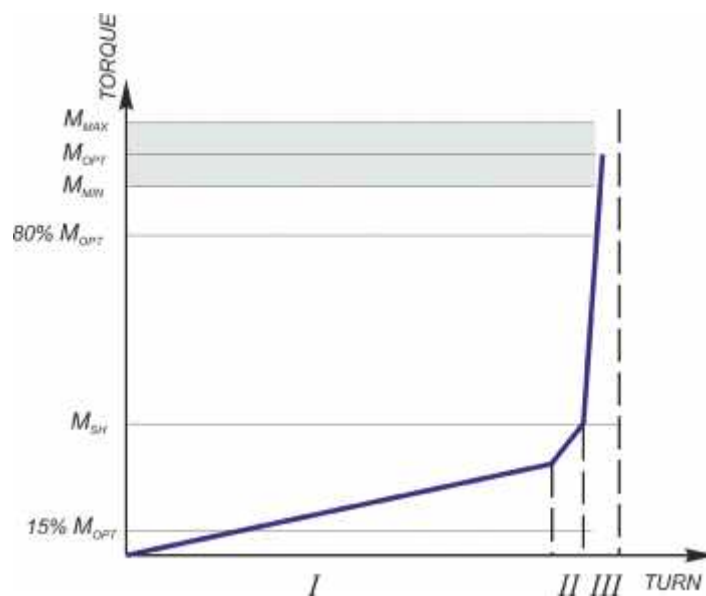

Figure 10 – Make-up diagram. Slight torque increase in the area II

6.3.1.8 Too low value of shoulder torque M_{sh} of thread shoulders on make-up diagram (Figure 11) may result from:

- Unfavorable combination of technologic parameters of the connection;
- Compound contamination and/or thread seals.

Break out the connection, inspect it, if required clean off the compound and repeat make-up.

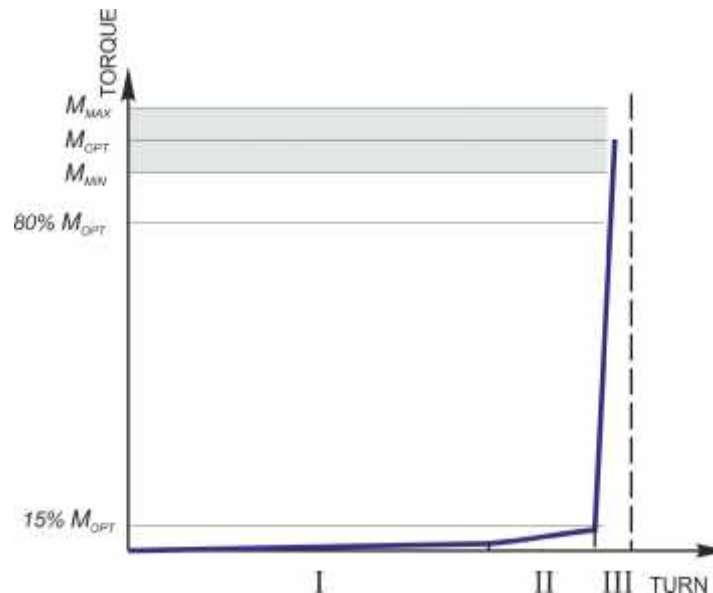

Figure 11 – Make-up diagram. Low value shoulder torque of thread shoulders

6.3.1.9 Too high value of shoulder torque M_{sh} on make-up curve (Figure 12) may result from:

- damage of thread and/or thread seals;
- improper thread cleaning;
- unfavorable combination of technologic parameters of the connection.

Break out the connection, inspect it, if required clean off the thread compound and repeat make-up.

If the shape of the make-up diagram after re-make-up is not changed, the pipe shall be laid aside and make-up with another pipe shall be performed. The pipe that was laid aside is allowed to be used for further make-ups if no damages, or damages that can be repaired, are observed (Attachment B). After the damages are repaired, the setting of equipment shall be checked and make-up shall be remade. If the shape of the make-up diagram, when being made-up with another pipe, is not changed, the connection shall be broken-out and the previous pipe shall be replaced.

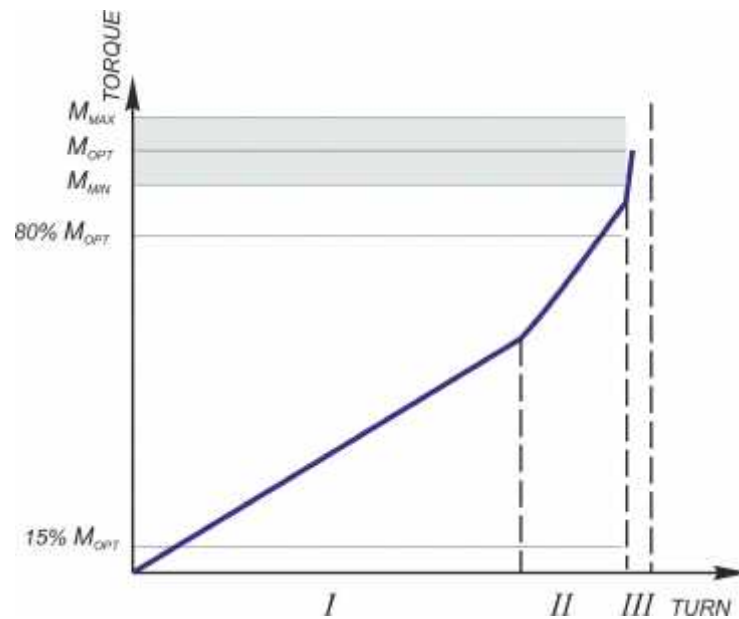

Figure 12 – Make-up diagram. High value shoulder torque of thread shoulders

6.3.1.10 Torque leaps on the make-up diagram (Figure 13) can be caused by:

- uneven application of thread compound and improper cleaning from preservative compound;
- Contamination of thread and/or thread seals.
- Damage of thread and/or thread seals;
- rotary tongs jam;
- uneven torque of rotation on shoulder.

Break out the connection, inspect it, if required clean off the thread compound and repeat make-up.

If the shape of the make-up diagram after remake-up is not changed, laid aside the pipe and perform make-up with another pipe. The laid aside pipe is allowed to be used for further make-up if no damages or damages that can be repaired are observed (Attachment B). After the damages are repaired, check the settings of equipment and repeat make-up.

If the shape of the make-up diagram when being made-up with another pipe is not changed, break out the connection and replace the previous pipe.

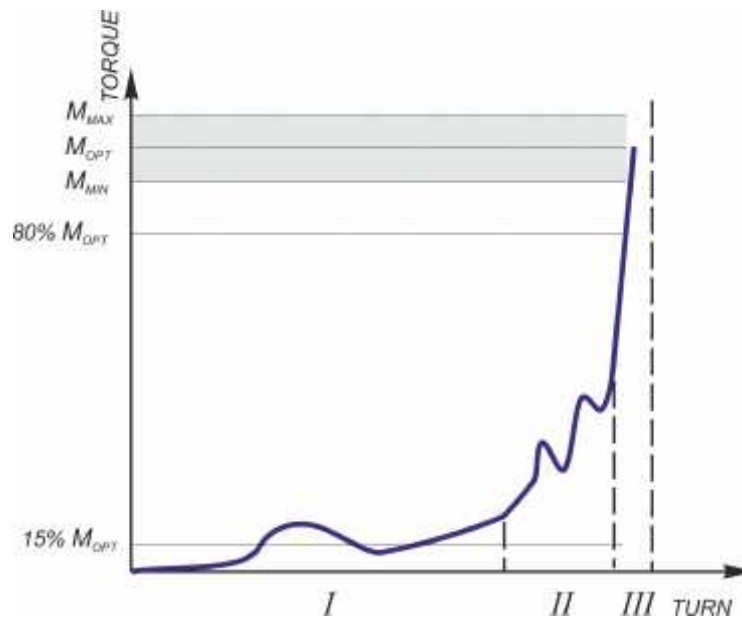

Figure 13 – Make-up diagram. Torque leaps

6.3.1.11 Make-up curve without clear shoulder torque sh (Figure 14) can result from:

- thread damage;
- improper thread cleaning;
- unfavorable combination of technologic parameters of the connection.

Break out the connection, inspect it, if required clean off the thread compound and repeat make-up.

If the shape of the make-up diagram after remake-up is not changed, lay aside the pipe and perform make-up with another pipe. The laid aside pipe is allowed to be used for further make-up if no damages or damages that can be repaired are observed (Attachment B). After the damages are repaired, check the settings of equipment and repeat make-up.

If the shape of the make-up diagram when being made-up with another pipe is not changed break out the connection and replace the previous pipe.

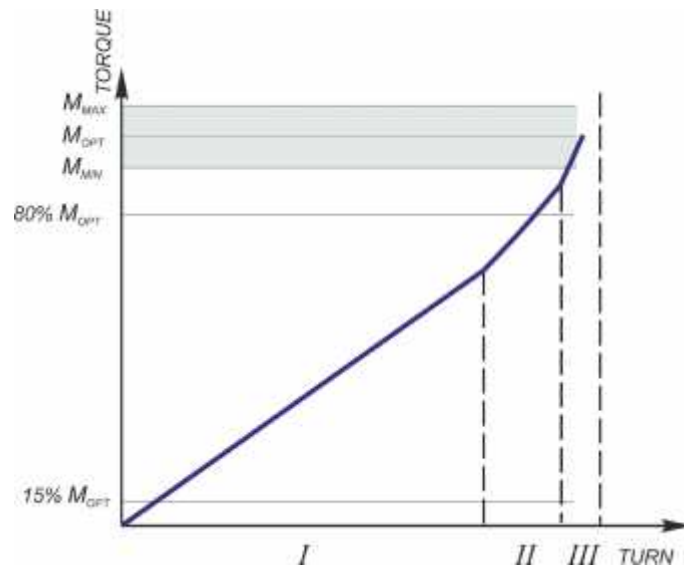

Figure 14 – Make-up diagram. No clear shoulder torque

6.3.1.12 Make-up curve with a wave-like effect not exceeding shoulder torque (Figure 15) can be caused by:

- improper thread cleaning;
- contamination of thread and/or thread seals;

Break out the connection, inspect it, if required clean off the thread compound and repeat make-up.

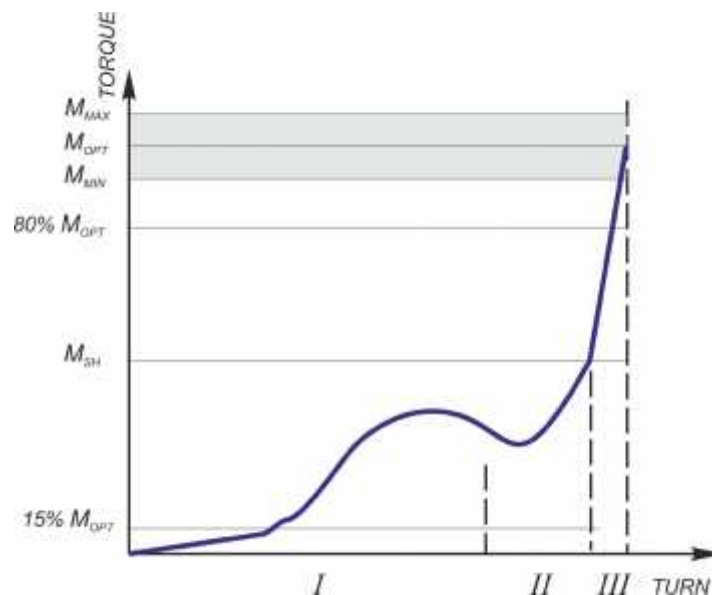

Figure 15 – Make-up diagram. Wave-like effect

6.3.1.13 Anytime the make-up curve on the diagram is of improper shape, break out the connection. Pin and coupling thread connections shall be inspected and cleaned if required. If visual inspection fails to find any damages or damages that can be repaired (Attachment B), check the equipment setting and repeat make-up. If the result of remake-up is the same as the result of the first make-up, the pipe shall be put aside and used during one of the further assemblies. If the results of the assembly with another pipe are not satisfactory, the pipe shall be rejected.

6.3.2 When inspection of make-up is performed by make-up triangle (transverse type), proper make-up is confirmed by alignment of coupling end face with the make-up triangle base (nearest edge of transverse stripe) on pipe with the tolerance of ±0.197 inches.

6.4 Break-out of string

6.4.1 When the string is being pulled out of the well, pipe end faces are not allowed to hit against coupling end faces.

6.4.2 Even longitudinal movement of the pipe resulted from gradual increase of number of engaged turns, shall be watched when the connection is broken-out.

6.4.3 The rotary tongs shall be adjusted as shown in the Figure 6 prior to break-out.

6.4.4 Break-out torque shall provide for the connection disassembly.

6.4.5 Speed of connection break-out by rotary tong shall correspond to the ones, specified in Table 5.

Table 5 - Speed of thread connection break-out

Break-out start		Break-out finish
First two turns	Further turns	
Speed maximum 2 rpm,	Speed maximum 10 rpm	Speed maximum 2 rpm

6.4.6 Break-out shall not cause significant mechanical damages like galling or jamming etc. on the pipe and coupling body.

The outer coupling surface shall be free of damages with the depth of more than 0,5 % from the coupling nominal outside diameter.

Damages from tong clamps are allowed on the pipe outer surface under condition that the actual pipe wall thickness taking into account that depth of the damage shall be not less than 87,5% from the nominal pipe wall thickness.

After break-out of chromium steel pipes and corrosion-proof steel pipes the marks on the pipe body shall not be deeper than 0,0079 inch.

6.4.7 When the string is disassembled immediately after break-out thread protective elements shall be installed onto pipe and coupling ends.

6.4.8 To store used pipes after string disassembly, if necessary, following preparations shall be carried out:

- visual inspection of thread protectors for damages;
- visual inspection of pipes and couplings for significant mechanical damages (like galling, jamming etc.) (See 5.2);
- visual inspection of thread, thread seals and thread shoulders surfaces of pins and coupling.

- application of preservation compound (like «Kendex OCTG» or equivalent) or preservative thread compound upon application of the preservation compound thread protectors shall be installed in accordance with it. 5.8.

6.4.9 In case of any damages detection, repair as per Attachment B or reject the pipes and couplings;

6.4.10 Delamination of GW compound from the pin or coupling thread surface with the size of not more than 20% from the covered surface with the possibility of further application is allowed. The examples of thread connection exterior view with GW compound of pin and coupling upon break-out of string are specified in Figures 18 and 19.



Figure 18 – Pin



Figure 19 – Coupling

6.4.11 In case of excess of allowed compound delamination (It. 6.4.10) repair compound shall be applied in accordance with Attachment B.

7 Manufacturer's warranty

Provided that the present recommendations are met, UP F thread connection shall withstand at least 3 make-up and break-out cycles preserving the same technical characteristics.

Attachment

(mandatory)

Equipment for make-up registration

UP F thread connection shall be made-up using equipment for make-up registration and saving of make-up diagram (make-up curve) in a graphical or electronic format.

The curve is plotted based on torque values along vertical axis and number of turns along horizontal axis which shall have a linear scale. Only two last revolutions shall be displayed as torque increases at end of make-up.

When using a computer make-up diagram shall have the following characteristics:

- Sufficient resolution (at least 800 × 600 pixels) for precise curve display. Display shall be at least 13,7795 inch in diagonal, herewith make-up curve shall take at least 80 % of display;
- Display of minimum and maximum torque with horizontal lines (if required, optimum torque shall be displayed).
- Display of minimum and maximum shoulder torque of thread shoulders with horizontal lines.
- Automatic and manual determination of shoulder torque of thread shoulders.
- Display of rig floor number of each make-up.
- Display of date and time of each make-up.
- Availability of comments.
- Display of company-customer name, well number, pipe diameter, weight, steel grade, type of thread connection, thread compound data and pipe manufacturer.
- When applicable, superimposing of latest make-up curve over the curves of previous satisfactory make-up diagrams;
- When applicable, display of make-up speed in rpm, either on the make-up curve or on a separate graph.

Displayed make-up results shall not be sufficient for acceptance or rejection of make-up operations. Correctness of make-up shall be confirmed by a competent specialist.

Prior to running the casing downhole, the calibration certificate with the latest and next planned equipment calibration dates shall be checked!

Attachment B
(mandatory)

B.1. Possible damages that might occur on areas of thread surfaces, thread seals, thread shoulders of pipe and coupling thread connections before putting into operation and the ways of their removal are listed in Table B1.

If any unacceptable damages are detected on pipes, such pipes shall be rejected then and reported accordingly specifying pipes serial numbers, describing defects found with photos attached.

Table B 1 – Types of damages and methods of repair

Surface Area (Figure 1)	Type of damage	Damage Repair
1, 2, 5	Pit corrosion less than 0,0039 inch deep or insignificant surface rust	Manual repair (removal) using non-metal brush with soft bristle or polishing paper with grain 0
	Pit corrosion more than 0,0039 inch deep	Not to be repaired, shall be rejected
	Burrs less than 0,0118 inch wide. Tears and scratches less than 0,0039 inch deep	Manual repair using needle file or polishing paper with grain 0
	Dents, nicks and other mechanical damages	Not to be repaired, shall be rejected
	Corrosion spots	Processing (removal) with corrosion converter with further cleaning by dry cloth
3, 6	Pit corrosion less than 0,0118 inch deep or insignificant surface rust	Manual repair using needle file or polishing paper
	Pit corrosion more than 0,0118 inch deep	Not to be repaired, shall be rejected
	Burrs less than 0,0118 inch wide. Tears and scratches less than 0,0118 inch deep	Manual repair using needle file or polishing paper with grain 0
	Corrosion spots	Processing (removal) with corrosion converter with further cleaning by dry cloth
4	Pit corrosion of any depth	Not to be repaired, shall be rejected
	Insignificant surface rust	Buffing
	Burrs, tears and scratches	Not to be repaired, shall be rejected
	Nicks	Not to be repaired, shall be rejected
	Small grooves	Buffing
	Corrosion spots	Processing (removal) with corrosion converter with further cleaning by dry cloth

B.2. Determination of corrosion depth, scratches, tears, burrs height shall be performed upon removal of GW compound in the area of defect:

- a mould made of a detected defect using special tape (material "X Coarse" of Testex company for defects up to 0,0039 inch deep, for deeper defects: X-Coarse Plus or equivalent). Mould height shall be measured with a thickness gage, measurement accuracy shall be at least 0,0004 inch (PEACOCK G2-127 or equivalent).



a) – Surface of pin connection



b) – Surface of coupling connection

1 – imperfect profile thread; 2 – perfect profile thread; 3 – cylinder groove;
 4 – radial thread seal; 5 – thread shoulder, 6 – tapered bore.

Figure B.1 – Surfaces of pin and coupling connections

- depth gage with a needle-type contact point (contact point diameter shall be maximum 0,0039 inch), measurement precision shall be minimum 0,0004 inch (PEACOCK -4 or equivalent).

B.3 Possible types of damages of thread, thread seals and thread shoulders surfaces of pipes and couplings during make-up, as well as repair methods are specified in Table B 2.

Table B 2 – Types of damages and methods of its repair

Surface area	Type of damage	Method of repair	Maximum time allowed for repair
Figure B 1 4	Any damages	Not to be repaired	n/a
Figure B1 1,2,3,5,6	Severe damages	Not to be repaired	n/a
Figure B1 2,3,5,6	Light damages	Manual repair. Use polishing paper with grain 100÷150 micro micron	10 min
Figure B1 1	Moderate damages on a thread length maximum 4 turns	Manual repair. Use needle file 2, 3 and polishing paper with grain 100÷150 micro micron for the further treatment	10 min
Figure B2 (,b)	Moderate damages on a thread length maximum 4 turns	Manual repair. Use needle file 2, 3 and polishing paper with grain 100÷150 micro micron for the further treatment	10 min

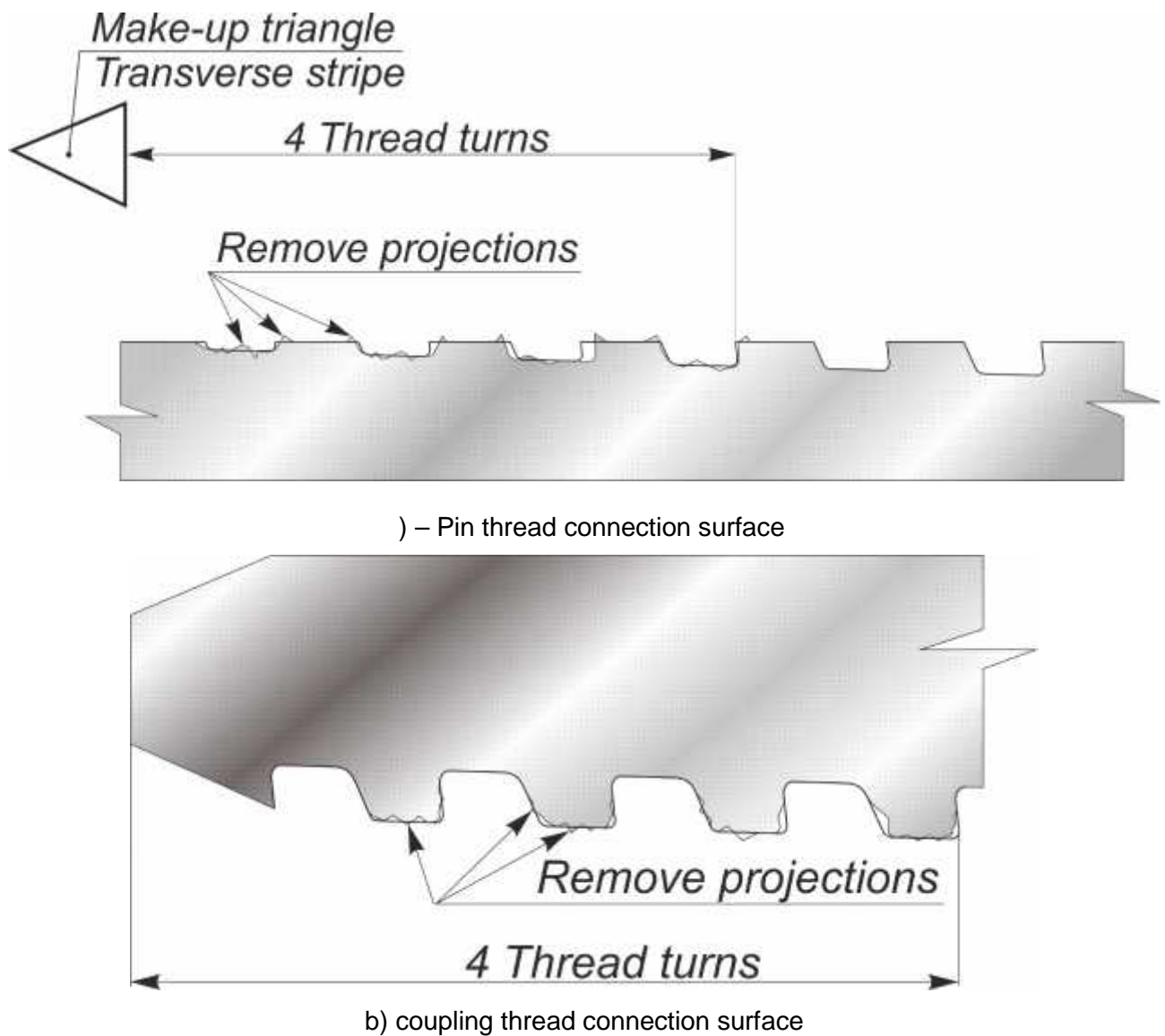

Figure B 2 – Surface areas of pin and coupling connections

B. 4 If upon repair or break-out surface coating damages are more than 20% of the area of coupling with GW compound, damaged areas shall be covered with “RUSMA Polimer Premium P” repair compound applied with a brush in a uniform layer.

B.5 If upon repair or break-out surface coating damages are more than 20% of the area of pin with GW compound, damaged areas shall be covered with “RUSMA Polimer Premium P” repair compound applied with a brush in a uniform layer.

B.6 If damages are not more than 20% of the area of pin and coupling with GW compound, coating repair is not required.

If repair compound is not available further use of pipes shall be carried out only using the recommended thread compound in accordance with Attachment B.

Attachment C
(Recommended)

Thread compound application

C.1 To ensure optimum conditions for make-up and to avoid burrs of mating surfaces, all surfaces of thread, thread seals and thread shoulders of pins and couplings shall be provided with thread compound. Thread compound shall comply with API RP 5A3/ISO 13678.

The following thread compounds are recommended:

- RUSMA-1 as per TU 0254-001-46977243-02
- RUSMA-R-4 as per TU 0254-031-46977243-04
- RUSMA-SP as per TU 0254-102-46977243

While make-up of chromium steel pipes RUSMA-14 compound shall be used as per TU0254-068-46977243.

Upon coordination with the connection designer, other than mentioned thread compounds can be applied; provided they comply with RP 5A3/ISO 13678 requirements and provide for thread connection sealability, as well as for protection from galling and corrosion.

C.2 Thread compound for make-up shall only be taken from original packages, delivered by the supplier, the container shall show name, batch number and manufacturing date.

Compound from packages without proper identification shall never be used.

Compound shall never be placed in other packages or dissolved!

Compound applied shall be homogeneous, of ointment consistency, free from any solid inclusions (stones, sand, dry compound, fine chips, etc.).

Prior to use, check compound's expiration date on the package. Never apply compound with expired shelf life.

Make sure you follow the recommendations specified below when using thread compound:

- use the same compound (the same type) when assembling one casing string;
- use a new compound package for each running, if the compound from opened package is used, make sure it is free from foreign inclusions;
- stir the compound thoroughly before use;

- warm up compound before application in case of freezing temperatures.

Compound shall be stored in closed overturned packages at the temperature specified by the manufacturer. When storing partially unused compound always specify the date of the first use on the package.

C.3 Thread compound shall be applied with an homogenous layer on all thread surface, thread seals and thread shoulders of pins and couplings connections. Figures C1 and C2 demonstrate proper and improper application of compound.

Compound shall be applied only to thoroughly cleaned and dried surfaces of thread connection.

Never use metal brushes for compound application!

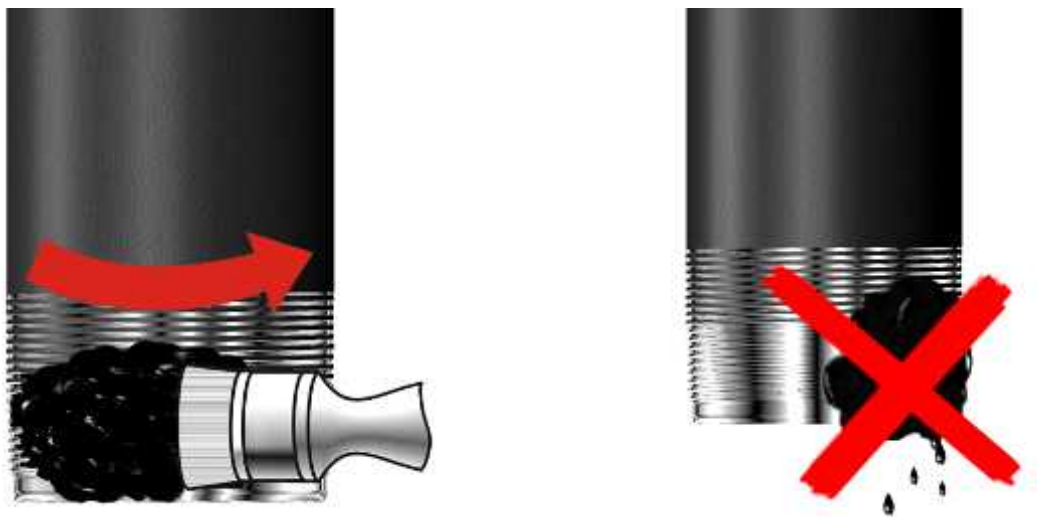

Figure C.1 – Proper and Improper application of thread compound

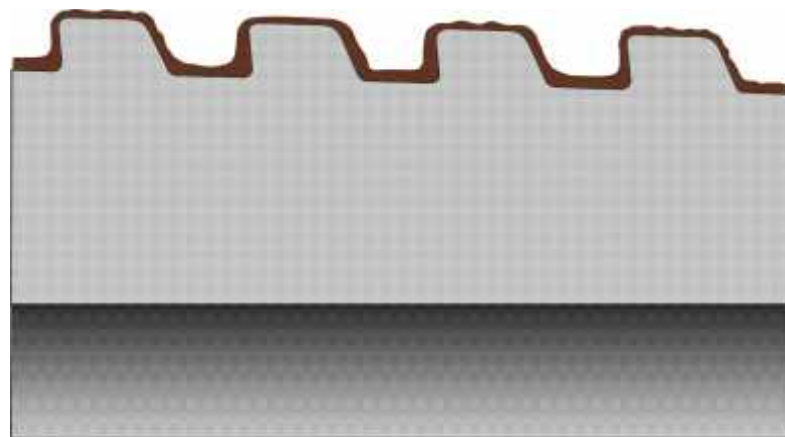

Figure C.2 – Proper distribution of thread compound over thread profile

C.4 Required amount of thread compound shall be distributed between coupling and pin ends as follows: two thirds shall be at the coupling and one third shall be at the pin.

Minimum and maximum compound amount, m_{min} and m_{max} , in grams, required for make-up one connection, shall be calculated as follows:

$$m_{min} = 0,014 \quad D \quad (C.1)$$

$$m_{max} = 0,017 \quad D \quad (C.2)$$

where: m_{min} – minimum compound amount, g, rounded to the nearest whole number;

m_{max} – maximum compound amount, g, rounded to the nearest whole number;

D – nominal outside diameter, inch, rounded to the nearest whole number.

Example - Minimum thread compound required for make-up of one threaded connection of pipes with nominal diameter of 4,5000 inch:

$$M_{min} = 0,014 \quad 4,5000 = 0,0630 \quad \approx 0,06 \text{ lb}$$

Here with, at least 0,04 lb shall be applied on coupling end and at least 0,02 lb – on pin.

To determine the quantity of compound required for determined number of pipes, a package of compound with specified volume shall be used.

Prior to pipes running down the hole, make sure that required thread compound is available.

C.5 Thread sealant can be used for make-up pipes with crossovers or other string elements provided the below conditions are followed:

- shoulder torque of thread shoulders is within the limits of minimum and maximum make-up torque;

- shoulder torque of thread shoulders is from 70 % to 80 % of optimum make-up torque, and the torque of rotation on shoulder is higher than optimum torque;

- shoulder torque of thread shoulders is higher than 80 % of optimal make-up torque and it does not result from thread jamming or damage, and 20 % of optimum make-up torque is applied after the shoulders interlock.