



APPROVED BY

Director of Development
TMK - Premium Services LLC



D.V. Nikiforov
19 november 2016

**Guidelines
For Use of Casing
with TMK UP PF ET Thread Connection**

RE PS 02-004-2011

Revision 3

CHECKED BY

Head of Experimental Design Bureau
TMK - Premium Services LLC



A.S. Myslevtsev
25 november 2016

DESIGNED BY

Head of Serial Design Bureau
TMK - Premium Services LLC



E.V. Leonov
24 november 2016

2016

ontents

Introduction	3
1 Scope.....	4
2 Normative references.....	4
3 Terms and definitions.....	4
4 Transportation, handling operations and storage.....	5
4.1 Transportation.....	5
4.2 Handling operations.....	6
4.3 Stockholding and storage.....	7
5 Preparation of pipes for make-up.....	8
5.1 General provisions.....	8
5.2 Visual inspection.....	9
5.3 Thread protectors removal.....	9
5.4 Compound removal.....	9
5.5 Thread connection inspection.....	10
5.6 Drifting.....	13
5.7 Measurement of length of pipes.....	13
5.3 Thread protectors installation.....	14
6 Make-up of pipes.....	15
5.5 Application of thread copound.....	15
4.2 Running and Pulling.....	18
6.3 Assembly of string.....	19
6.4 Make-up inspection.....	25
6.3 Break-out of string.....	35
7 Manufacturer's warranty.....	36
Attachment (mandatory) Equipment for make-up registration.....	37

Introduction

The present guidelines are worked out taking into account the requirements of the following documents:

- API RP 5C1 Recommended Practice for Care and Use of Casing and Tubing;
- API RP 5 1 Gaging and Inspection of Casing, Tubing and Pipe Line Threads;
- ISO 10405 Petroleum and Natural Gas Industries – Care and Use of Casing and Tubing.
- TR CU 010/2011 – Technical Regulations of EAEC “on the Safety of Machinery and Equipment”.

Guidelines for Use of Casing with UP PF ET Thread Connection

Effective date 25 – 12 – 2016

1 Scope

The present guidelines contain recommendations for maintenance and use of casing with TMK UP F ET thread connection under field conditions, including pipe preparation and make-up, string running and pulling operations, as well as guidelines for pipe handling, storage and inspection during operation.

2 Normative references

The present guidelines contain normative references to the following documents:

API RP 5A3/ISO 13678 Recommended Practice on Thread Compounds for Casing, Tubing and Line Pipe;

TU 0254-001-46977243-02 RUSMA-1 Thread Compound;

TU 0254-031-46977243-04 RUSMA P-4 Thread Compound;

TU 0254-068-46977243-2011 RUSMA P-14 Thread Compound;

TU 0254-102-46977243-2011 RUSMA SP Thread Compound;

Note. – The specified document revision shall be applied for dated references. The latest valid revision shall be applied for undated references.

3 Terms and definitions

For the purposes of the present guidelines the standard terms as well as the following terms and definitions shall be applied:

3.1 **metal-to-metal seal:** Seal or sealing system, that relies on intimate and usually high contact stress of a metal surface to achieve a seal.

3.2 **rotation on shoulder:** Excessive turns after shoulder to ensure thread connection tightness.

3.3 **pin (pin connection):** A thread connection on Oil Country Tubular Goods (OCTG) that has external (male) threads and/or seal, shoulder.

3.4 **box (box connection):** A thread connection in Oil Country Tubular Goods (OCTG) that has internal (female) threads and/or seal, shoulder.

3.5 **thread seals:** Box seal and pin seal.

3.6 **thread shoulders:** Pin shoulder and box shoulder.

3.7 **pin shoulder:** Pin face which serves as an arrester during make-up.

3.8 **box shoulder:** Internal barrier which serves as an arrester during make-up.

3.9 **pin seal:** Area of the pin external surface which provides for tightness of the thread connection during make-up.

3.10 **box seal:** Area of the box internal surface which provides for tightness of the thread connection during make-up.

4 Transportation, handling operations and storage

4.1 Transportation

4.1.1 When pipes are transported by sea, railroad (railcars) or trucks, Cargo Shipping Rules and Technical Provisions for Cargo Handling and Fastening applicable to the particular transport type shall be observed.

4.1.2 Pipe transportation, handling and storage shall be carried out with thread protectors screwed on pin and coupling end-faces in order to protect thread surface, thread shoulders and thread seals from exposure.

4.1.3 Pipe bundles of different lots and standard sizes can be loaded into same means of transportation, but have to be separated.

4.1.4 Pipe bundles shall be securely fastened during transportation to avoid any movement. Wooden blocks can be used for fastening purposes.

When several pipe bundles are stacked or not bundled pipes are stacked into several ranks, pipe bundles and pipe ranks shall be separated by at least three wooden blocks, with the thickness from 1.3780 – 1.5748 inch each, so that weight of upper pipe ranks is not distributed onto couplings of lower ranks.

4.1.5 When transported by sea, pipe bundles shall not be placed in water inside the vessel's hold or in any other corrosive environment. Dragging of bundles along the piles or hitting bundles against hatches or rails is strictly forbidden.

4.1.6 When loading pipe bundles into railway cars or trucks, wooden girders (blocks) shall be provided for car floors or vehicle beds to ensure required distance between the products and uneven bottom of the vehicle. No blocks shall be placed under couplings.

4.1.7 Pipes from chromium and corrosion-resistant steel shall be packaged using wooden or plastic beds.

4.1.8 In order to avoid hitting of pipes against vehicle metal elements or protruding parts of neighbouring pipe bundles, it is recommended to use load platforms with protecting covers.

4.1.9 When attaching pipe bundles to loading platform or deck it is required to use nylon cables.

4.2 Handling operations

4.2.1 All handling operations with pipes shall be carried out with thread protectors screwed on pin and coupling ends.

4.2.2 Handling operations with pipe bundles shall be carried out only with the help of hoisting transportation clamps.

In case of manual unloading, rope slings shall be used and pipes shall be rolled along guides in parallel to the pile, avoiding quick movement and collision of pipe ends that might result in pipe and coupling thread damage even with protectors in place.

When using the crane, spreader beams with slings shall be used according to approved slinging diagrams.

4.2.3 Pipes shall not be allowed to fall down from heights or be picked up by the upper pipe end in a bundle with a hook or be dragged or subjected to any other actions that might damage pin and coupling threads, surfaces or shapes.

4.2.4 Handling operations with chromium steel pipes shall be performed using nylon or steel harnesses with plastic braid. When using forklift, gripping forks, frames and clamps with nonmetallic coating shall be used.

4.2.5 Handling operations for chromium steel pipes shall exclude collision with hard bodies having sharp edges that can result in sufficient local increase of pipe surfaces hardness and affect the sulphide stress cracking resistance.

4.3 Stockholding and storage

4.3.1 Pipe storage conditions shall comply with GOST 15150 for Group 4 (long-term storage) or Group 8 (short-term storage: up to three months and service interruptions).

4.3.2 Pipes stockholding shall be performed in compliance with Materials, Equipment and Spare Parts Stockholding and Storage Guidelines at production and technical maintenance facilities ensuring their preservation and avoiding damage of pin and coupling threads, surfaces or shapes.

4.3.3 Pipe bundles shall be stacked on supports spaced in a manner avoiding sagging or thread damage. Rack supports shall be located in one plane and shall not sag under pile weight. Rack bearing surface shall be minimum 11.8110 inch above the ground or floor.

Pipe bundles shall not be stocked on the ground, rails, steel or concrete floor!

There shall be no stones, sand, and dirt on racks!

4.3.4 When several pipe bundles are stacked or not bundled pipes are stacked into several ranks, pipe bundles and pipe ranks shall be separated by at least three wooden blocks, with the thickness from 1.3780 – 1.5748 inch each, so that weight of upper pipe ranks is not distributed onto couplings of lower ranks.

The height of the pipe pile shall not exceed 9.8425 ft.

4.3.5 Stockholding of unbundled pipes is allowed provided vertical posts are installed in the racks.

4.3.6 If pipes are rolled on the racks, any movements at an angle to the rack axis shall be excluded as this may result in collision of pins and damage of thread or thread protectors.

4.3.7 During pipe storage, availability and integrity of thread protectors, as well as compound underneath and its expiration date shall be inspected. Pipe corrosion shall not be allowed.

4.3.8 During pipe storage with RUSMA-SP compound for more than 6 months or for more than 12 months the compound under safety parts shall be renewed before usage.

For this purpose the following actions shall be performed:

- remove thread protectors according to para. 5.3;
- remove initial compound according to para. 5.4;
- apply rust-preventing compound (Kendex OCTG type or similar) with the expiration date of minimum 6 months – till the next compound renewal or pipe usage;
- install the thread protectors that were previously removed, make sure they are cleaned from old compound, or new thread protectors according to para. 5.8.

4.3.9 Pipes damaged during transportation, rejected during inspection, prepared for repair or awaiting a final decision shall be stored on separate racks with the corresponding tags.

4.3.10 During chromium steel pipes storage, wood or plastic gaskets shall be placed onto all pipe supports.

4.3.11 Drilling site shall have special area for pipe stockholding in compliance with above-listed requirements.

4.3.12 Required quantity of racks shall be installed at drilling site in order to provide for stockholding of full set of pipes.

While stacking onto racks it is important to consider the order of string running (if it is specified in the work instruction) to be sure that the first pipe according to the work plan is not under the

pipes that shall be run later. Pipes shall be placed onto racks in such a way so that to ensure couplings are facing the wellhead.

5 Preparation of pipes for make-up

5.1 General provisions

Prior to lifting the pipes onto the rig site, proceed as follows:

- perform visual inspection of pipes and couplings;
- remove thread protectors from pipes and couplings;
- remove preservation compound from pin and coupling thread connections;
- inspect pin and coupling surfaces;
- drift pipes along the entire length;
- measure the length of each pipe;
- re-install clean thread protectors on pins and couplings.

5.2 Visual inspection

Visual inspection of pipes, couplings and thread protectors shall be performed in order to detect bent pipes, dents and damages.

Visual inspection of pipes and couplings shall be carried out with protectors screwed on.

Pipes, couplings, thread protectors with significant damages, discovered during visual inspection shall be put aside awaiting decision on their suitability for use.

Amount of damaged pipes shall be specified in the Product Quality Non-conformity Protocol and all damaged areas shall be documented on photographs.

5.3 Thread protectors removal

°°°Thread protectors shall be removed after thread connections are visually inspected.

Thread protectors shall be removed manually or using a special tong with one person effort. In case of difficulties when removing thread protectors, heating of thread protectors with steam is allowed or striking slightly with a wooden hammer at a protector's end to eliminate a possible distortion.

5.4 Compound removal

Upon removal of thread protectors, pin and coupling thread connections shall be cleaned from compound by hot soapy water or with a steam cleaner. It is recommended to supply water under pressure. In case of freezing temperature, compound may be removed by using solvent (Nefras, white spirit or similar). After compound is removed, thread connection shall be purged with compressed air or cleaned with dry rags.

**Compound shall not be removed using
diesel, kerosene, salty water, barite or metal brushes!**

Barite or metal brushes can cause scratches on surfaces of thread seals resulting in loss of tightness.

After compound is removed, thread connections shall be purged with compressed air or cleaned with dry rags.

When using RUSMA-1 thread compound, RUSMA-SP or similar thread compound under thread protectors, the compound removal is not required. At the same time make sure that:

- the compound is free of foreign particles;
- compound is applied onto thread in an even layer (make the surface even and/or add the compound of the same type if necessary);
- the service life of compound is not expired and the pipe was manufactured not more than 3 months ago.

5.5 Thread connection inspection

Thread connection shall be inspected by the following specialists:

- crews for casing strings assembly;
- companies specialized in casing inspection;

When running casing for the first time, representatives of the casing supplier shall be present.

When inspecting pin and coupling connections, including thread surface, thread seals and shoulders make sure you pay due attention to the following:

- damages resulting from pipes collisions or other impacts;
- damages resulting from installation of thread protectors;
- rust, corrosion or other chemical damages caused as a result of environmental exposure or due to aggressive compound components.

Under low light condition (twilight, night) individual portable light source shall be used during inspection.

Possible damages that might occur on areas of thread surfaces, thread seals, thread shoulders of pin and coupling thread connections before putting into operation and the ways of their removal are listed in Table 1.

Determination of corrosion depth, scratches, tears, burrs height shall be performed using:

- a mould made of a detected defect using special tape (X Coarse material of Testex company for defects up to 0.0039 inch deep, for deeper defects: X-Coarse Plus or equivalent). Mould height shall be measured with a thickness gage, measurement accuracy shall be at least 0.0039 inch (PEACOCK G2-127 or equivalent);

- depth gage with a needle-type contact point (contact point diameter shall be maximum

0.0039 inch), measurement precision shall be minimum 0.0039 inch (PEACOCK -4 or equivalent).

If any unacceptable damages are detected on pipes, such pipes shall be rejected then and reported accordingly specifying pipes serial numbers, describing defects found with photos attached.

Table 1 – Types of damages and methods of repair

Surface area (Figure 1)	Type of damage	Damage Repair
1, 2, 5	Pit corrosion less than 0.0039 inch deep or insignificant surface rust	Manual repair (removal) using non-metal brush with soft bristle or polishing paper with grain 0
	Pit corrosion more than 0.0039 inch deep	Not to be repaired
	Burrs less than 0.0118 inch wide. Tears and scratches less than 0.0039 inch deep	Manual repair using needle file or polishing paper with grain 0
	Dents, nicks and other mechanical damages	Not to be repaired
3.6	Pit corrosion less than 0.0118 inch deep or insignificant surface rust	Manual repair using needle file or polishing paper.
	Pit corrosion more than 0.0118 inch deep	Not to be repaired
	Burrs less than 0.0118 inch wide. Tears and scratches less than 0.0118 inch deep	Manual repair using needle file or polishing paper with grain 0
4	Pit corrosion of any depth	Not to be repaired
	Insignificant surface rust	Buffing
	Burrs, tears and scratches	Not to be repaired
	Nicks	Not to be repaired
	Small grooves	Buffing

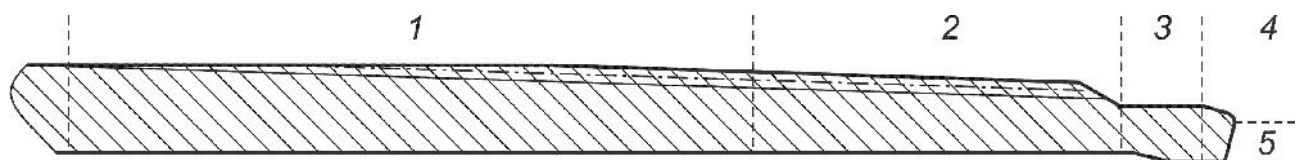

a) – Surface of external thread connection

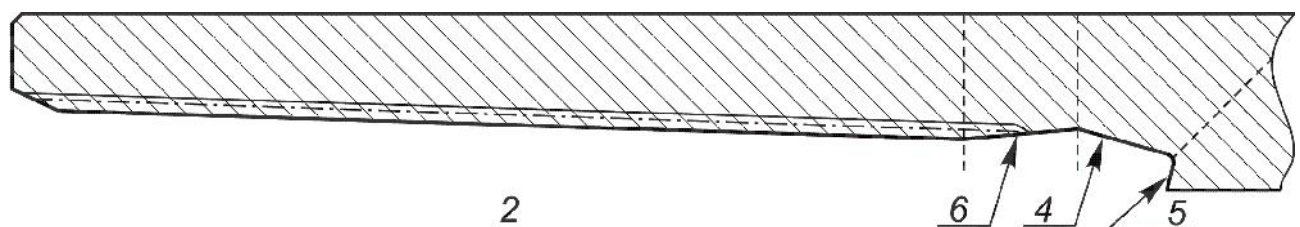

b) – Surface of internal thread connection

1 – imperfect profile thread; 2 – perfect profile thread; 3 – cylinder groove; 4 – conical thread seal; 5 – thread shoulder 6 – tapered bore;

Figure 1 – Surfaces of pin and box connection

Possible types of damages of thread, thread seals and thread shoulders surfaces of pins and couplings during make-up, as well as repair methods are specified in Table 2.

Table 2 – Types of damages and methods of repair

Surface area	Type of damage	Method of repair	Maximum time allowed for repair
Figure 1 4	Any damages	Not to be repaired	n/a
Figure 1 1,2,3,5	Severe damages	Not to be repaired	n/a
Figure 1 2,3,5	Light damages	Manual repair. Use polishing paper with grain 100÷150 micro micron	10 min
Figure 2 (a, b)	Moderate damages on a thread length maximum 4 turns	Manual repair. Use needle file 2, 3 and polishing paper with grain 100÷150 micro micron for the further treatment	10 min

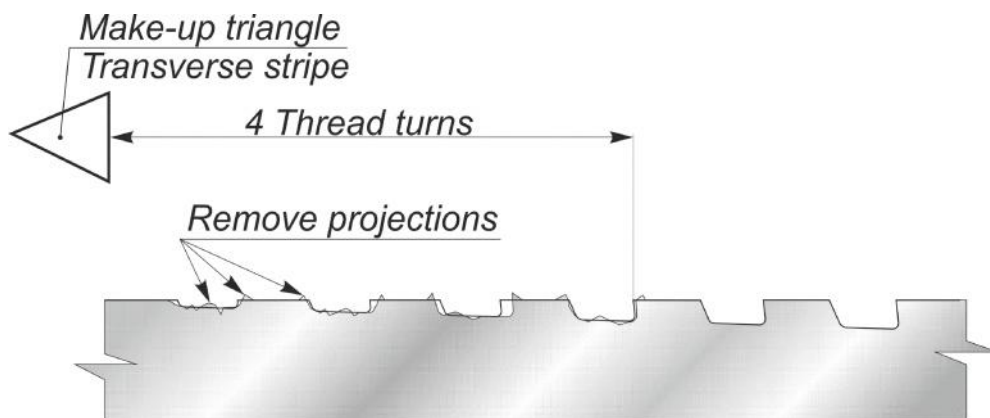

a) – Surface of external thread connection

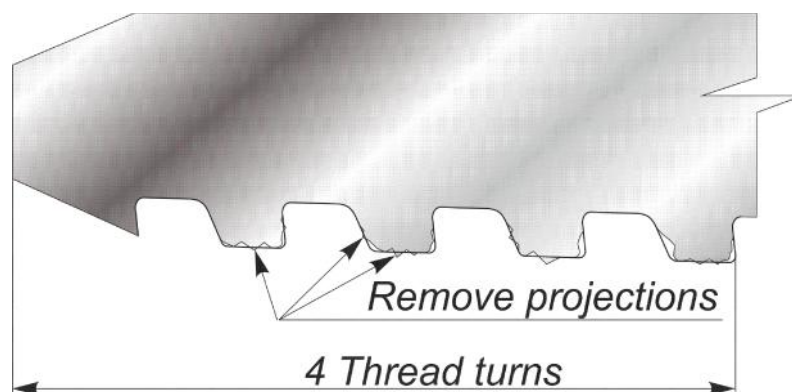

b) – Surface of internal thread connection

Figure 2 – Surface of pin and box connections

5.6 Drifting

Pipes should be checked by drift along the entire length of the pipe. For pipes made of chromium and corrosion-resistant steels polymer or aluminium drifts shall be used.

Before drifting, the pipe shall be positioned in such a manner as to avoid sagging. If any ropes or bars are used for the drifting process, they shall be clean. In case of freezing temperatures pipes shall be heated prior to drifting, to remove snow and ice crust.

Pipe and drift shall be of the same temperature during drifting process.

Dimensions of the drift effective part shall comply with those specified in Table 2. Diameter of the effective part of the drift shall be checked in three planes along the entire length after each 50 pipes check. If the diameter decreases by more than 0.0197 inch in any of the three planes, such a drift shall be rejected.

The drift shall pass through the entire pipe, when pulled manually without significant effort.

If the drift cannot pass through the pipe, such a pipe shall be replaced with another pipe.

Pipes rejected during drifting process, shall be put aside until further decision on their validity.

Table 3 – Dimensions of the effective part of the drift

Pipe outside diameter, inch	Length of the effective part of the drift, inch	Diameter of the effective part of the drift, inch
up to 8 5/8 incl.	5.9843	$d - 1/8$
9 5/8 – 13 5/8	12.0079	$d - 5/32$
Note – d is a nominal pipe inside diameter.		

5.7 Measurement of length of pipes

Length of each pipe shall be measured from free (without a thread protector) coupling end-face to free (without thread protector) pin end-face.

It is recommended to compare measured pipe length with the marked length. In case of discrepancies the measured length shall be marked on pipe body with a marker or chalk.

When calculating the total length of the string, one should use the formula specified below

$$L = L - n L \quad (1)$$

where L – the total length of the string;

L – overall length of pipes in a string, measured from pin end-face to free coupling end-face;

n – number of pipes in a string;

L – decrease of length of pipes during make-up (ref. Table 4).

Table 4 – Decreasing of pipe length during make-up process

Pipe outside diameter, inch	Decrease of pipe length during make-up L , inch
4 1/2	4.0787
5	4.2008
5 1/2	4.2638
6 5/8	4.4843
7	4.6732
7 5/8	4.9134
8 5/8	5.0394
9 5/8	5.1024
9 7/8	5.1024
10 3/4	5.1417
11 3/4	5.1417
11 7/8	5.1417
12 3/4	5.1417
13 3/8	5.1417
13 5/8	5.1417

5.3 Thread protectors installation

Upon performance of inspection and control, thread protectors or caps shall be re-installed on pin and couplings ends.

Removed thread protectors can be re-used on the condition that prior to installation they have been thoroughly cleaned (including cleaning from conservation compound that was earlier applied) and do not have considerable damages, affecting protection of thread and thread seals from direct environmental impact.

Cleaning of protectors from conservation compound shall comply with the requirements for cleaning of pin and coupling thread connections according to para. 5.4.

6 Make-up of pipes

6.1 Application of thread compound

6.1.1 To ensure optimum conditions for make-up and to avoid burrs of mating surfaces, all surfaces of thread, thread seals and thread shoulders of pins and couplings shall be provided with thread compound. Thread compound shall comply with requirements specified in API RP 5A3/ISO 13678.

The following thread compounds are recommended:

- RUSMA-1 as per TU 0254-001-46977243-02;
- RUSMA -4 as per TU 0254-031-46977243-04;
- RUSMA SP as per TU 0254-102-46977243.

While making-up pipes of chromium steels RUSMA P-14i compound shall be used per TU 0254-068-46977243.

Upon coordination with the connection designer, other than mentioned thread compounds may be applied; provided they comply with RP 5A3/ISO 13678 requirements and provide for thread connection sealability, as well as for protection from galling and corrosion.

6.1.2 Thread compound for make-up shall only be taken from original packages, delivered by the supplier, the container shall show name, batch number and manufacturing date.

Compound from packages without proper identification shall never be used.

Compound shall never be placed in other packages or dissolved!

Compound applied shall be homogeneous, of ointment consistency, free from any solid inclusions (stones, sand, dry compound, fine chips, etc.).

Prior to use, check compound's expiration date on the package. Never apply compound with expired shelf life.

Make sure you follow the recommendations specified below when using thread compound:

- use the same compound (the same type) when assembling one casing string;
- use a new compound package for each running, if the compound from opened package is used, make sure it is free from foreign inclusions;
- stir the compound thoroughly before use;
- warm up compound before application in case of freezing temperatures.

Compound shall be stored in closed overturned packages at the temperature specified by the manufacturer. When storing partially unused compound always specify the date of the first use on the package.

6.1.3 Thread compound shall be applied with an even layer on the whole thread surface, thread seals and thread shoulders of pins and couplings connections. Figures 3 and 4 demonstrate proper and improper application of compound.

Compound shall be applied only on thoroughly cleaned and dried (as per para. 5.4) surfaces of thread connection.

Never use metal brushes for compound application!

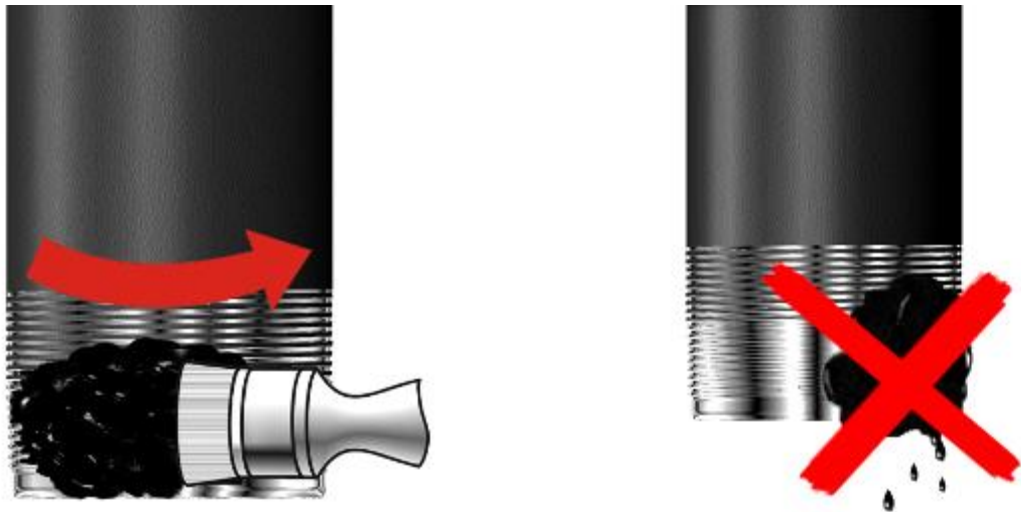

Figure 3 – Proper and improper application of thread compound

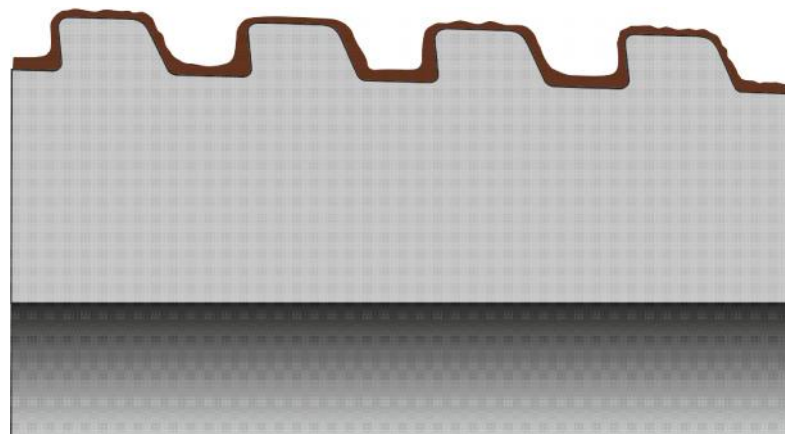

Figure 4 – Proper distribution of thread compound over thread profile

6.1.4 Required amount of thread compound shall be distributed between coupling and pin ends as follows: two thirds shall be on the coupling end and one third shall be on the pin end.

The minimum and the maximum compound mass m_{\min} and m_{\max} in lb for make-up of one thread connection shall be calculated as follows:

$$m_{\min} = 0.014 D \quad (2)$$

$$m_{\max} = 0.017 D \quad (3)$$

where m_{\min} is the minimum compound mass in lb rounded to an integral value;

m_{\max} is the maximum compound mass in lb rounded to an integral value;

D – nominal outside diameter, inch, rounded to an integral value.

Example – The minimum quantity of thread compound required for make-up of one thread connection of pipes with an outside diameter of 4.5000 inch:

$$m_{\min} = 0.014 \cdot 4.5000 = 0.0630 \approx 0.06 \text{ lb}$$

at that at least 0.04 lb shall be applied on coupling end and at least 0.02 lb on pin.

To determine the quantity of compound required for determined number of pipes, a package of compound with specified volume shall be used.

Prior to pipes running down the hole, make sure that required thread compound is available.

6.1.5 Thread sealant can be used for make-up of pipes with crossovers or other string elements provided the below conditions are followed:

- shoulder torque of thread shoulders is within the limits of minimum and maximum make-up torques;
- shoulder torque of thread shoulders is from 70 % to 80 % of optimum make-up torque, and the torque of rotation on shoulder is higher than optimum make-up torque;
- shoulder torque of thread shoulders is higher than 80 % of optimal make-up torque and it does not result from thread jamming or damage, and 20 % of optimum make-up torque is applied after the shoulders interlock.

6.2 Running and Pulling

6.2.1 Casing shall be assembled by a qualified operator. To ensure declared operational features of thread connection, make-up shall be performed with make-up torque registration system applicable.

If make-up torque registration system is not available then the following shall be used in priority-oriented order:

- manometer of breakout tong (conversion of pressure into torque in compliance with the tong manufacturer recommendations);
- make-up triangle (cross stripe) and make-up marks.

6.2.2 A special stab guide or bell guide is recommended for running and pulling operations (Figure 5). The devices help to align pin and coupling and prevent the connection from damage

6.2.3 In order to decrease risk of new damages during running and pulling operations, it is recommended to use pipe weight balancer.

6.2.4 While running string of chrome steel pipes one should better use elevator or special wedge claws to avoid pipe body damages.



Figure 5 – Make-up with special bell guide

6.2.5 Rotary tongs shall be equipped with a speed governor and ensure speed of 1 rpm at the final stage of make-up.

Tongs shall be equipped with clamps for specific pipe sizes to ensure a larger contact area with the pipe body. Clamp diameter shall be 1 % greater than pipe outside diameter. Clamps shall be adjusted in such a way that they hold the pipe tightly and never slip.

For make-up and break-out of chromium steel pipes, the rotary tongs shall be equipped with non-metal or non-injurious tong dies.

Prior to make-up, tongs shall be positioned as per Figure 6.

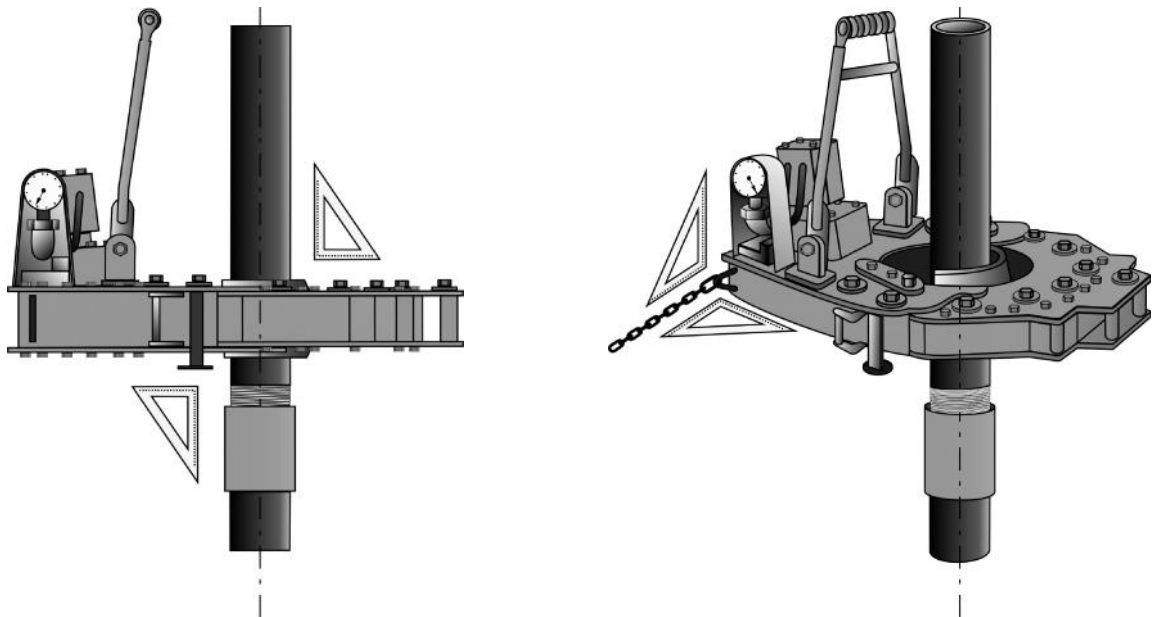

Figure 6 – Rotary tongs positioning before make-up

6.2.6 Make-up equipment shall ensure torque at least 30% greater than recommended maximum make-up torque. Breaking-off requires higher torque than make-up.

6.3 Assembly of string

6.3.1 Make sure thread protectors are secured in place prior to lifting pipes onto the rig floor.

Lifting pipes to the rig floor without thread protectors or end caps is not allowed!

6.3.2 Prior to assembly of the string remove thread protectors and check by touch surfaces of thread seals and thread shoulders of the free pin for any mechanical damage, check for alignment of the assembled pipes (Figures 7 and 8).

6.3.3 Compound shall be applied according to para. 6.1. It is recommended to perform air blasting of external and internal threads prior to compound application.

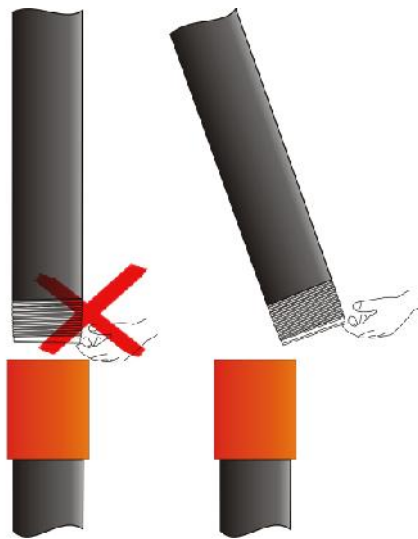

Figure 7 – Mechanical damage inspection

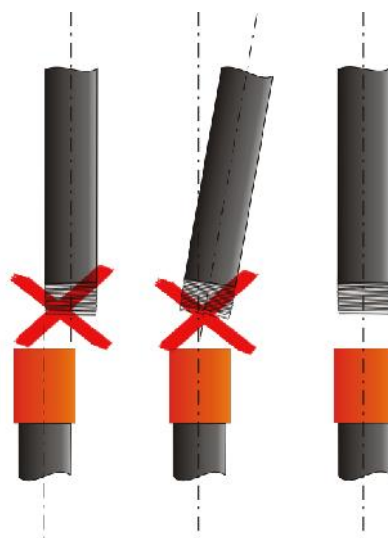

Figure 8 – Alignment inspection

6.3.4 When stabbing pin into coupling, pin end-face shall not hit coupling end-face, pin sliding down into the coupling, when pin end-face contacts coupling end-face is not allowed.

6.3.5 Make sure prior to make-up, that surfaces of thread, thread seals and thread shoulders with applied compound are free from mud or mud laden fluid with small contaminations, hindering tightness of connection. In case of mud or mud laden fluid on connection surfaces, clean them and apply thread compound again.

6.3.6 Make-up shall be performed with the torque specified in Table 5.

If thread connection make-up with torque within the limits shown in Table 5 is not in compliance with specified requirements, T_{opt} can be corrected but not more than by $\pm 10\%$. At that the values of T_{min} and T_{max} shall be corrected but not more than by $\pm 10\%$ from corrected T_{opt} .

6.3.7 During make up of pins and couplings made of steels of different grades, the make-up torque value shall be chosen according to the lowest steel grade of both pin and coupling.

6.3.8 Make-up of pins and couplings can be performed with the use of torque values registering equipment, by make-up diagrams, or without such equipment, by visual make-up marks.

Make-up with torque values registering equipment is the preferred one as it allows assessing make-up quality by the diagrams. The equipment used shall comply with the requirements specified in the Attachment .

Make-up without registering equipment shall be performed based on make-up torques and make-up marks on pin and coupling, applied by the manufacturer (in light paint), and the make-up triangle on the pin (Figure 9) or make-up marks on pin and coupling and the make-up triangle on the pin (Figure 9), applied by the manufacturer (in light paint). A transverse stripe (in light paint) can be made on the pin instead of the make-up triangle, in such a case a triangular sign (in light paint), denoting position of the make-up triangle, shall not be painted.

6.3.9 When making-up pin and coupling, the first two turns shall be carried out manually. Application of chain tong is also allowed.

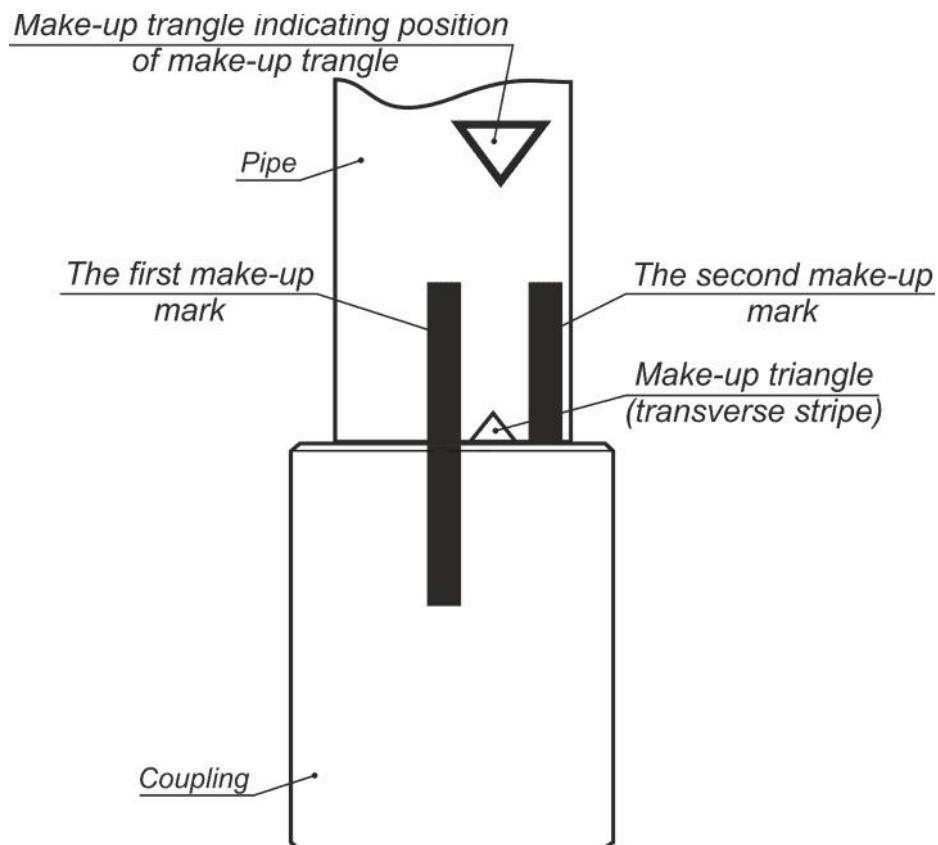

Figure 9 – Make-up with make-up marks and make-up triangle

Table 5 – Make-up torques

D, Inch	S, Inch	Torque, ft lb for steel grades																										
		J55, K55			N80, L80			90			R95, 95,T95			110, 110			Q125			Q135			TMK140			TMK150		
		min	opt	max	min	opt	max	min	opt	max	min	opt	max	min	opt	max	min	opt	max	min	opt	max	min	opt	max	min	opt	max
4 1/2	0,2500	3500	3800	4200	4400	4800	5300	5000	5600	6100	5000	5600	6200	5500	6000	6600	6000	6600	7300	6400	7200	7800	6800	7500	8300	7000	7700	8600
	0,2902	4000	4400	4900	5000	5600	6200	5800	6500	7200	5800	6500	7200	6300	7000	7700	7000	7700	8600	7400	8300	9100	7700	8700	9600	8000	9000	10000
	0,3370	4300	4700	5200	5600	6200	6800	6300	7000	7700	6300	7000	7700	6900	7700	8400	7700	8500	9400	8200	9100	10000	8700	9600	10500	9000	10000	10900
5	0,2961	4400	4900	5400	5500	6100	6700	5900	6600	7200	5900	6600	7200	6600	7400	8100	7300	8100	8900	8100	9000	9900	8600	9500	10400	8900	9900	10800
	0,3618	5400	6000	6600	6700	7400	8200	7200	8000	8800	7200	8000	8800	8200	9100	10000	9000	10000	11000	9800	10900	12000	10400	11600	12700	10800	12000	13200
	0,4370	6200	6900	7500	7700	8600	9400	8800	9800	10800	8800	9800	10800	9700	10800	11900	10900	12100	13300	11400	12600	13900	11900	13300	14600	12300	13800	15200
	0,4780	6700	7400	8200	8500	9400	10400	9700	10700	11800	9700	10700	11800	10600	11800	13000	11900	13200	14500	12500	13900	15300	13100	14600	16200	13600	15200	16700
	0,5000	7000	7800	8600	8900	9900	10800	10000	11100	12200	10000	11100	12200	11100	12400	13600	12500	13900	15300	13100	14500	16000	13900	15300	16800	14400	15900	17500
5 1/2	0,2748	4600	5200	5700	5700	6300	7000	6300	7100	7800	6300	7100	7800	7200	8000	8800	7900	8800	9700	8300	9300	10300	8800	9800	10800	9100	10200	11300
	0,3039	5200	5800	6300	6300	7000	7700	7000	7800	8600	7000	7800	8600	7900	8800	9700	8700	9700	10600	9300	10300	11400	9800	10800	12000	10200	11300	12500
	0,3610	5900	6600	7200	6900	7700	8400	7800	8700	9600	7800	8700	9600	9100	10200	11200	10200	11300	12400	10200	11300	12400	10800	11900	13100	11100	12300	13600
	0,4150	6900	7600	8300	7900	8800	9700	9000	10000	11000	9000	10000	11000	10500	11700	12800	11700	12900	14200	11700	12900	14200	12200	13600	15000	12700	14200	15600
	0,4760	7800	8700	9600	9400	10500	11500	10300	11400	12500	10800	11900	13100	12000	13300	14700	13300	14700	16200	13300	14800	16300	14600	16200	17800	15100	16800	18500
6 5/8	0,2882	7700	8500	9400	9200	10300	11300	10500	11700	12800	10500	11700	12800	11800	13100	14500	13000	14400	15900	13600	15000	16500	14300	15900	17500	14800	16500	18100
	0,3150	8300	9200	10200	10000	11100	12200	11500	12800	14000	11500	12800	14000	12800	14200	15600	14200	15700	17300	14700	16400	18000	15600	17300	19000	16200	17900	19700
	0,3520	9300	10300	11400	11200	12500	13700	12800	14200	15600	12800	14200	15600	14300	15900	17600	15800	17600	19300	16400	18300	20100	17400	19300	21200	18100	20100	22100
	0,4169	11000	12200	13500	13300	14700	16200	15100	16800	18500	15100	16800	18500	17000	18900	20800	18700	20700	22800	19500	21700	23800	20600	22900	25100	21400	23700	26100
	0,4748	12500	13900	15300	15100	16800	18500	17200	19100	21000	17200	19100	21000	19300	21500	23600	21200	23600	26000	22300	24700	27200	23500	26000	28700	24300	27100	29800
7	0,2720	6900	7600	8300	8800	9800	10800	9900	11000	12100	9900	11000	12100	10800	12000	13200	12200	13500	14800	13000	14500	15900	13700	15200	16700	14200	15800	17300
	0,3169	8000	8800	9700	10300	11400	12600	11500	12800	14000	11500	12800	14000	12600	14000	15400	14200	15700	17300	15100	16800	18500	16000	17700	19500	16600	18400	20300
	0,3618	9100	10200	11200	11700	13000	14300	13000	14500	15900	13000	14500	15900	14300	15900	17600	16000	17800	19500	17200	19100	21000	18100	20100	22200	18700	20900	23000
	0,4079	10300	11400	12600	13200	14700	16200	14700	16300	17900	14700	16300	17900	16200	18000	19800	18100	20100	22100	19500	21600	23700	20400	22700	25000	21200	23600	26000
	0,4531	11500	12800	14000	14800	16400	18100	16400	18300	20100	16400	18300	20100	18100	20100	22100	20200	22400	24600	21800	24200	26600	23000	25500	28000	23900	26500	29100
7 5/8	0,4980	12600	14000	15400	16300	18100	19900	18100	20100	22100	18100	20100	22100	19900	22100	24300	22200	24600	27100	23900	26500	29200	25300	28000	36500	26300	29100	36500
	0,3000	10300	11500	12700	12200	13600	14900	13900	15400	17000	13900	15400	17000	14900	16500	18100	16200	17900	19700	17900	19900	21900	19000	21000	23100	19700	21800	24000
	0,3280	11300	12500	13800	13300	14800	16300	15100	16800	18500	15100	16800	18500	16300	18100	19900	17600	19600	21600	19600	21800	24000	20700	23000	25300	21500	23900	26300
	0,3748	13600	15000	16500	16500	18400	20200	19000	21000	23200	19000	21000	23200	21200	23500	25900	22900	25400	27900	24300	27000	29700	25600	28500	36500	26600	29600	36500
	0,4299	15600	17300	19000	19000	21000	23200	21600	24000	26500	21600	24000	26500	24300	27000	29700	26300	29100	32100	27800	33200	36500	29400	33200	36500	29900	33200	36500
	0,5000	18000	20000	22000	22000	24400	26800	25200	28000	30800	25200	28000	30800	28200	31300	34500	29900	33200	36500	29900	33200	36500	29900	33200	36500	29900	33200	36500
8 5/8	0,5618	20300	22500	24800	24800	27500	30200	28200	31400	34600	28200	31400	34600	29900	33200	36500	29900	33200	36500	29900	33200	36500	29900	33200	36500	29900	33200	36500
	0,5949	22400	24900	27400	28200	31300	34400	29900	33200	36500	29900	33200	36500	29900	33200	36500	29900	33200	36500	29900	33200	36500	29900	33200	36500	29900	33200	36500
	0,3039	12500	13900	15300	14700	16300	17900	18100	20100	22100	18100	20100	22100	19700	21900	24100	20900	23200	25400	21600	24000	26400	22700	25300	27800	23600	26300	28800
	0,3520	14500	16100	17700	17000	18900	20800	20900	23300	25700	20900	23300	25700	22900	25400	27900	24200	26800	29500	24900	27700	36500	26300	29300	36500	27300	33200	36500
	0,4000	16300	18100	20000	19300	21500	23600	22500	25000	27500	22500	25000	27500	25100	27900	30800	27600	30600	33700	28400	33200	36500	29900	33200	36500	29900	33200	36500
	0,4500	18400	20500	22600	21800	24200	26600	25300	28100	30900	25300	28100	30900	28200	31400	34600	29900	33200	36500	29900	33200	36500	29900	33200	36500	29900	33200	36500
0,5000	20500	22800	25100	24300	26900	29600	28200	31300	34500	28200	31300	34500	29900	33200	36500	29900	33200	36500	29900	33200	36500	29900	33200	36500	29900	33200	36500	
0,5571	22900	25400	27900	26900	29900	33000	29700	33000	36400	29700	33000	36400	29900	33200	36500	29900	33200	36500	29900	33200	36500	29900	33200	36500	29900	33200	36500	

End of Table 5

D, Inch	S, Inch	Torque, ft lb for steel grades																										
		J55, K55			N80, L80			90			R95, 95,T95			110, 110			Q125			Q135			TMK140			TMK150		
		min	opt	max	min	opt	max	min	opt	max	min	opt	max	min	opt	max	min	opt	max	min	opt	max	min	opt	max	min	opt	max
9 5/8	0,3520	20100	22300	24500	21100	23500	25800	23500	26000	28600	23800	26500	29100	26600	29600	32500	29600	32800	36100	29900	33200	36500	29900	33200	36500	29900	33200	36500
	0,3949	22400	24900	27400	23600	26300	28900	26300	29100	32100	26700	29600	32600	29800	33100	36400	29900	33200	36500	29900	33200	36500	29900	33200	36500	29900	33200	36500
	0,4350	24600	27400	30100	26000	28800	31700	28800	32000	35200	29400	32600	35800	29900	33200	36500	29900	33200	36500	29900	33200	36500	29900	33200	36500	29900	33200	36500
	0,4720	26800	29700	32700	28200	31300	34400	29900	33200	36500	29900	33200	36500	29900	33200	36500	29900	33200	36500	29900	33200	36500	29900	33200	36500	29900	33200	36500
	0,5449	29900	33200	36500	29900	33200	36500	29900	33200	36500	29900	33200	36500	29900	33200	36500	29900	33200	36500	29900	33200	36500	29900	33200	36500	29900	33200	36500
	0,5949	29900	33200	36500	29900	33200	36500	29900	33200	36500	29900	33200	36500	29900	33200	36500	29900	33200	36500	29900	33200	36500	29900	33200	36500	29900	33200	36500
	0,6091	29900	33200	36500	29900	33200	36500	29900	33200	36500	29900	33200	36500	29900	33200	36500	29900	33200	36500	29900	33200	36500	29900	33200	36500	29900	33200	36500
	0,6720	29900	33200	36500	29900	33200	36500	29900	33200	36500	29900	33200	36500	29900	33200	36500	29900	33200	36500	29900	33200	36500	29900	33200	36500	29900	33200	36500
9 7/8	0,7339	29900	33200	36500	29900	33200	36500	29900	33200	36500	29900	33200	36500	29900	33200	36500	29900	33200	36500	29900	33200	36500	29900	33200	36500	29900	33200	36500
	0,7969	29900	33200	36500	29900	33200	36500	29900	33200	36500	29900	33200	36500	29900	33200	36500	29900	33200	36500	29900	33200	36500	29900	33200	36500	29900	33200	36500
	0,6252	29900	33200	36500	29900	33200	36500	29900	33200	36500	29900	33200	36500	29900	33200	36500	29900	33200	36500	29900	33200	36500	29900	33200	36500	29900	33200	36500
10 3/4	0,6610	29900	33200	36500	29900	33200	36500	29900	33200	36500	29900	33200	36500	29900	33200	36500	29900	33200	36500	29900	33200	36500	29900	33200	36500	29900	33200	36500
	0,7201	29900	33200	36500	29900	33200	36500	29900	33200	36500	29900	33200	36500	29900	33200	36500	29900	33200	36500	29900	33200	36500	29900	33200	36500	29900	33200	36500
	0,3500	15800	17600	19300	21700	24100	26500	22900	25400	28000	25700	28600	31500	28000	31100	34200	29900	33200	36500	29900	33200	36500	29900	33200	36500	29900	33200	36500
	0,4000	19900	22100	24300	27400	30400	33400	28900	32100	35300	29900	33200	36500	29900	33200	36500	29900	33200	36500	29900	33200	36500	29900	33200	36500	29900	33200	36500
	0,4500	24600	27300	30000	29900	33200	36500	29900	33200	36500	29900	33200	36500	29900	33200	36500	29900	33200	36500	29900	33200	36500	29900	33200	36500	29900	33200	36500
	0,4949	28400	31600	34700	29900	33200	36500	29900	33200	36500	29900	33200	36500	29900	33200	36500	29900	33200	36500	29900	33200	36500	29900	33200	36500	29900	33200	36500
11 3/4	0,5449	29900	33200	36500	29900	33200	36500	29900	33200	36500	29900	33200	36500	29900	33200	36500	29900	33200	36500	29900	33200	36500	29900	33200	36500	29900	33200	36500
	0,5949	29900	33200	36500	29900	33200	36500	29900	33200	36500	29900	33200	36500	29900	33200	36500	29900	33200	36500	29900	33200	36500	29900	33200	36500	29900	33200	36500
	0,6720	29900	33200	36500	29900	33200	36500	29900	33200	36500	29900	33200	36500	29900	33200	36500	29900	33200	36500	29900	33200	36500	29900	33200	36500	29900	33200	36500
	0,3331	18400	20500	22600	25300	28100	30900	29900	33200	36500	29900	33200	36500	29900	33200	36500	29900	33200	36500	29900	33200	36500	29900	33200	36500	29900	33200	36500
	0,3752	22400	24900	27400	29900	33200	36500	29900	33200	36500	29900	33200	36500	29900	33200	36500	29900	33200	36500	29900	33200	36500	29900	33200	36500	29900	33200	36500
11 7/8	0,4350	27400	30400	33400	29900	33200	36500	29900	33200	36500	29900	33200	36500	29900	33200	36500	29900	33200	36500	29900	33200	36500	29900	33200	36500	29900	33200	36500
	0,4890	29900	33200	36500	29900	33200	36500	29900	33200	36500	29900	33200	36500	29900	33200	36500	29900	33200	36500	29900	33200	36500	29900	33200	36500	29900	33200	36500
	0,5339	29900	33200	36500	29900	33200	36500	29900	33200	36500	29900	33200	36500	29900	33200	36500	29900	33200	36500	29900	33200	36500	29900	33200	36500	29900	33200	36500
	0,5819	29900	33200	36500	29900	33200	36500	29900	33200	36500	29900	33200	36500	29900	33200	36500	29900	33200	36500	29900	33200	36500	29900	33200	36500	29900	33200	36500
12 3/4	0,5500	29900	33200	36500	29900	33200	36500	29900	33200	36500	29900	33200	36500	29900	33200	36500	29900	33200	36500	29900	33200	36500	29900	33200	36500	29900	33200	36500
	0,5819	29900	33200	36500	29900	33200	36500	29900	33200	36500	29900	33200	36500	29900	33200	36500	29900	33200	36500	29900	33200	36500	29900	33200	36500	29900	33200	36500
	0,3740	25700	28600	31500	29900	33200	36500	29900	33200	36500	29900	33200	36500	29900	33200	36500	29900	33200	36500	29900	33200	36500	29900	33200	36500	29900	33200	36500
	0,4331	29900	33200	36500	29900	33200	36500	29900	33200	36500	29900	33200	36500	29900	33200	36500	29900	33200	36500	29900	33200	36500	29900	33200	36500	29900	33200	36500
13 3/8	0,4882	29900	33200	36500	29900	33200	36500	29900	33200	36500	29900	33200	36500	29900	33200	36500	29900	33200	36500	29900	33200	36500	29900	33200	36500	29900	33200	36500
	0,5512	29900	33200	36500	29900	33200	36500	29900	33200	36500	29900	33200	36500	29900	33200	36500	29900	33200	36500	29900	33200	36500	29900	33200	36500	29900	33200	36500
	0,3799	28200	31300	34500	29900	33200	36500	29900	33200	36500	29900	33200	36500	29900	33200	36500	29900	33200	36500	29900	33200	36500	29900	33200	36500	29900	33200	36500
	0,4299	29900	33200	36500	29900	33200	36500	29900	33200	36500	29900	33200	36500	29900	33200	36500	29900	33200	36500	29900	33200	36500	29900	33200	36500	29900	33200	36500
13 5/8	0,4799	29900	33200	36500	29900	33200	36500	29900	33200	36500	29900	33200	36500	29900	33200	36500	29900	33200	36500	29900	33200	36500	29900	33200	36500	29900	33200	36500
	0,5142	29900	33200	36500	29900	33200	36500	29900	33200	36500	29900	33200	36500	29900	33200	36500	29900	33200	36500	29900	33200	36500	29900	33200	36500	29900	33200	36500
	0,5551	29900	33200	36500	29900	33200	36500	29900	33200	36500	29900	33200	36500	29900	33200	36500	29900	33200	36500	29900	33200	36500	29900	33200	36500	29900	33200	36500
13 5/8	0,6252	29900	33200	36500	29900	33200	36500	29900	33200	36500	29900	33200	36500	29900	33200	36500	29900	33200	36500	29900	33200	36500	29900	33200	36500	29900	33200	36500
	0,7598	29900	33200	36500	29900	33200	36500	29900	33200	36500	29900	33200	36500	29900	33200	36500	29900	33200	36500	29900	33200	36500	29900	33200	36500	29900	33200	36500

N o t e. Make-up with special couplings shall be performed using torque 20% less than the specified.

6.3.10 When making-up chromium steels pipes, the first two turns shall be carried out manually, or a strap tong can be used (Figure 10). Chain tong is allowed for use only under condition that the pipe body is secured from damage (e.g. by the safe gasket which is set between the pipe body and the tong).



Figure 10 – Make-up start with strap tongs

6.3.11 Make-up rotation speed during connection make-up with the rotary tong shall correspond to the values specified in Table 6.

Table 6 – Rotation speed during make-up

Start of make-up		End of make-up (rotation on shoulder)
First two turns	Further turns	
Speed maximum 2 rpm, Better manually	Speed maximum 10 rpm	Speed maximum 2 rpm

6.3.12 Even longitudinal movement of the pipe resulting from gradual increase of number of engaged revolutions, shall be watched, significant warming of the connection (not more than 122 °F of the ambient temperature) shall not be allowed.

6.3.13 Make-up shall not cause significant mechanical damages like galling, jamming or other imperfections on pipe and coupling body.

The outer surface of coupling shall be free of damages with the depth larger than 0.5% from the coupling nominal outside diameter.

Damages from tong clamps are allowed on the pipe outer surface under condition that the actual pipe wall thickness taking into account depth of the damage shall be not less than 87,5% from the nominal pipe wall thickness.

After make-up of chromium steel pipes the trace depth on the pipe body shall be not more than 0.0079 inch.

6.3.14 At the initial stage of assembling it is recommended to perform the first two revolutions of pipe using chain tongs (chain tongs are allowed for use only with the safe gasket which is set between the pipe body and the tong thus avoiding pipe body damage) to assure of connection of external and internal threads, i.e. entering of external thread profile in mating profile of internal thread. At this stage pipe reversal half-revolution is allowed for steady continuation of make-up without threads overlapping and high-quality assembly.

6.3.15 When the maximum value of the final make-up torque (T_{max}) is achieved, turning of coupling from the side of mill connection is allowed, if the diagram is not changed during correct make-up (Figure 11). The final make-up torque values shall be within T_{min} to T_{opt} limits in order to reduce the probability of turning.

6.4 Make-up inspection

6.4.1 Make-up inspection by the make-up diagram

6.4.1.1 If make-up is performed correctly and all the thread connection geometric parameters comply with the requirements of the regulatory documentation, the make-up diagram will show defined areas, which correspond to torque increase due to thread surfaces mating (area I), and the further mating of thread seals and thread shoulders (area II and area III), as shown in the Figure 11 below.

The rotary torque increase on the first revolutions corresponding to the initial mating of thread surfaces shall be smooth and even. Further on with mating of thread surfaces and thread seals, acceleration of rotary torque shall increase till shouldering of the connection which shall be accompanied with the sharp increase in torque, and which confirms that make-up is performed correctly.

Depending on the rotary tong used and its adjustment the make-up diagram (especially in area I) can show areas with insignificant deviation from straight line: oscillations, leaps, etc. Such deviations shall be deemed acceptable if general view of the make-up diagram corresponds to the established requirements.

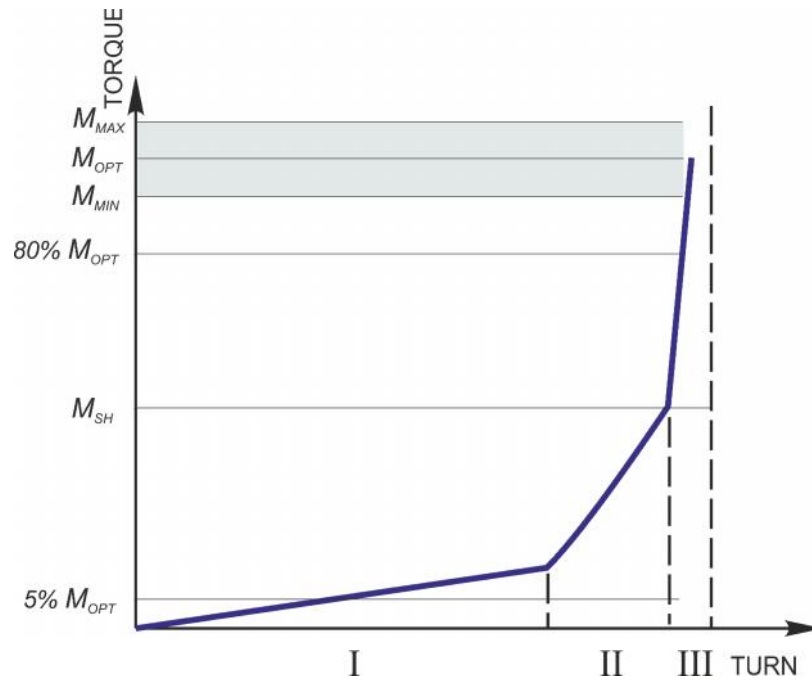

Figure 11 – Correct make-up diagram

6.4.1.2 The make-up diagrams for the pipes from the same lot shall be close in shape.

6.4.1.3 The shoulder torque M_{sh} of thread shoulders (box shoulder and pin shoulder) shall be within the range between 5 % and 80 % of the optimum make-up torque M_{opt} .

6.4.1.4 The final make-up torque shall be within the range from the minimum to the maximum make-up torques.

6.4.1.5 Typical cases of make-up diagram shape non-compliance are shown in Figures 12 – 17.

6.4.1.6 If at the final step of make-up procedure torque increase stops and there appears a horizontal area (area IV, Figure 11), but no slippage of clamp jaws is observed and the area IV length is maximum 0,12 of revolution, then such a make-up shall be considered acceptable. If not, the connection shall be broken-out, inspected for absence of damages and deformations. If during inspection of thread, thread seals and thread shoulders no surface damages or shape distortions, such as decrease of pin or box shoulder inside diameter, sagging on the box inside surface, are observed, or damages, that can be repaired (Table 2), are observed, re-assembly of the connection can be performed upon elimination of all the damages.

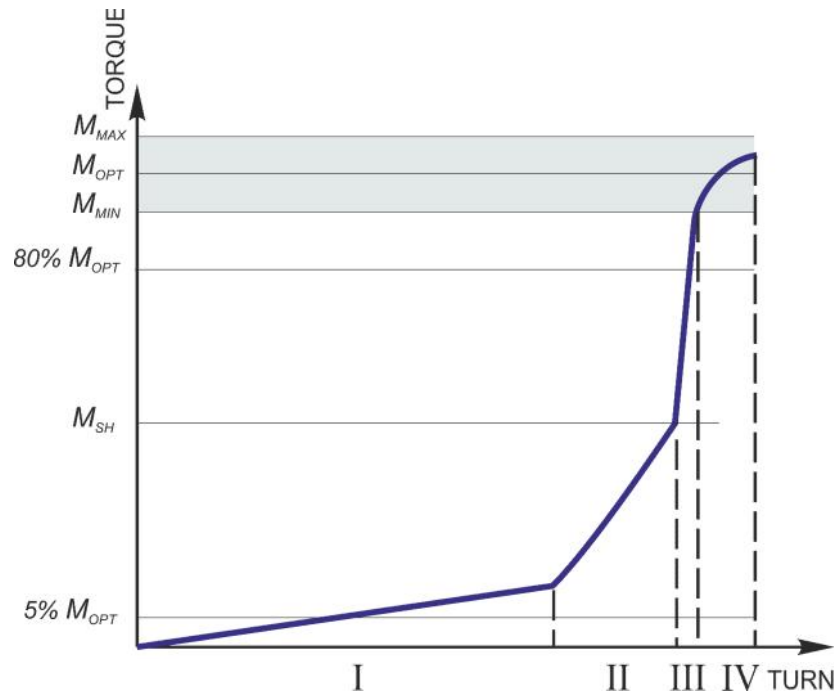

Figure 12 – Make-up diagram. Torque increase stopped in the area IV

6.4.1.7 If the make-up diagram shows slight torque increase due to mating of thread seals (area II, Figure 13), this might be caused by insufficient contact of seal surfaces, or a combination of high thread interference and low seal interference.

If the diagram has a proper shape, it shall be considered that the radial seal component on the make-up diagram is significantly smaller than the thread component, so its size is not always indicative, and such a connection shall be deemed acceptable. However, if there is any doubt in make-up correctness, break out the joint, clean off the compound and perform an inspection. If visual inspection reveals traces of contact on the thread seals, reapply thread compound of the appropriate type and quality and make-up again.

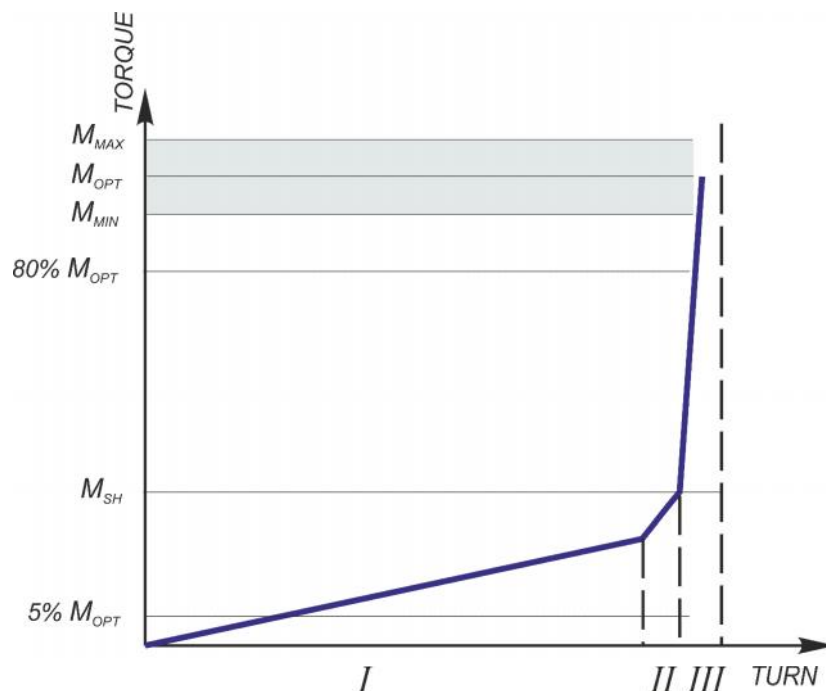

Figure 13 – Make-up diagram. Slight torque increase in the area II

6.4.1.8 Too low value of shoulder torque M_{sh} of thread shoulders on make-up diagram (Figure 14) may result from:

- unfavorable combination of technological parameters of the connection;
- application of wrong type of compound,
- compound contamination or its poor storage conditions.

Break out the connection, clean off the compound and inspect it. If the visual inspection is satisfactory, reapply thread compound of the appropriate type and quality and make-up the connection again.

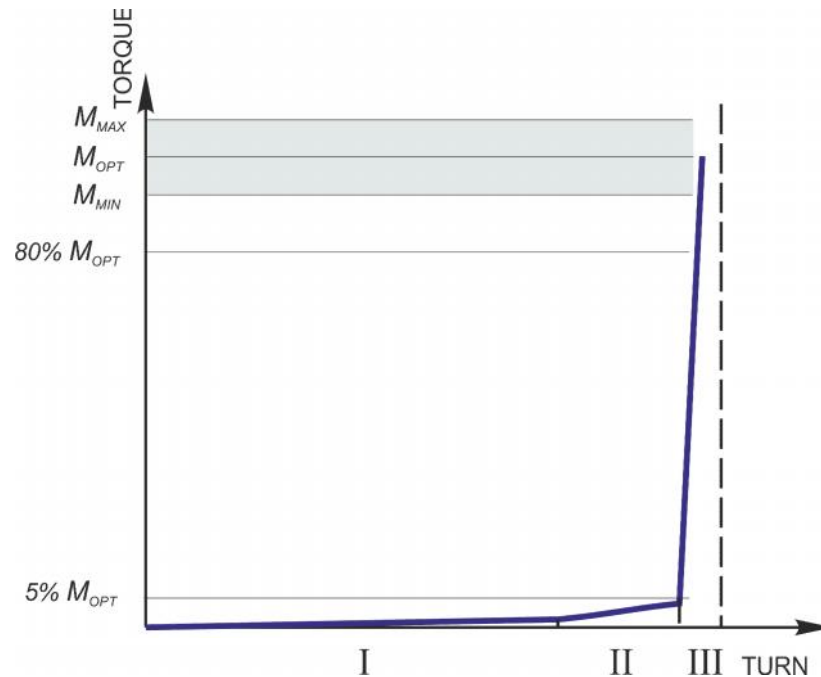

Figure 14 – Make-up diagram. Low value shoulder torque of thread shoulders

6.4.1.9 Too high value of shoulder torque M_{sh} of thread shoulders on make-up curve (Figure 15) may result from:

- damage of thread and/or thread seals;
- improper thread cleaning;
- application of wrong type of compound,
- thread compound contamination;
- high density of thread compound (e.g. at low temperatures);
- unfavorable combination of technological parameters of the connection.

Break out the connection, clean off the compound and inspect it. If the visual inspection is satisfactory, reapply thread compound of the appropriate type and quality and make-up the connection again.

If the shape of the make-up diagram after re-make-up is not changed, the pipe shall be laid aside and make-up with another pipe shall be performed. The pipe that was laid aside is allowed to be used for further make-ups if no damages, or damages that can be repaired, are observed (table 2). After the damages are repaired, the proper type and quality of thread compound shall be applied, the setting of equipment shall be checked and make-up shall be re-made. If the shape of the make-up diagram, when being made-up with another pipe, is not changed, the connection shall be broken-out and the previous pipe shall be replaced.

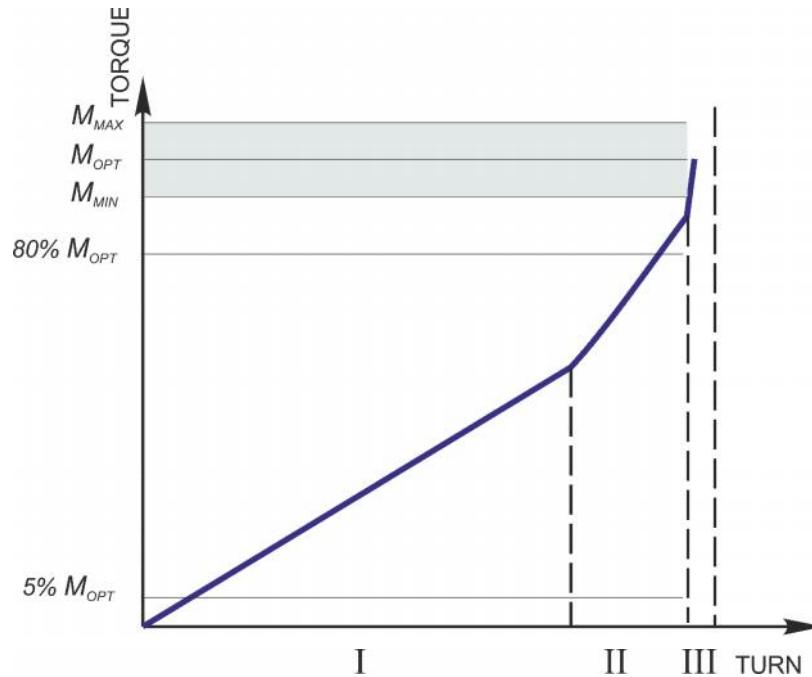

Figure 15 – Make-up diagram. High value shoulder torque of thread shoulders

6.4.1.10 Torque leaps on the make-up diagram (Figure 16) may result from:

- uneven application of thread compound and improper cleaning from preservation compound;
- rotary tongs jam;
- uneven force of rotation on shoulder.

Break out the connection, clean off the compound and inspect it. If the visual inspection is satisfactory, reapply thread compound of the appropriate type and quality and check the tong setting and repeat make-up.

If the shape of the make-up diagram after re-make-up is not changed, the pipe shall be laid aside and make-up with another pipe shall be performed. The laid aside pipe is allowed to be used for further make-up if no damages or damages that can be repaired are observed (Table 2). After the damages are repaired, reapply the thread compound of the appropriate type and quality, check the settings of equipment and repeat make-up.

If the shape of the make-up diagram, when being made-up with another pipe, is not changed, the connection shall be broken-out and the previous pipe shall be replaced.

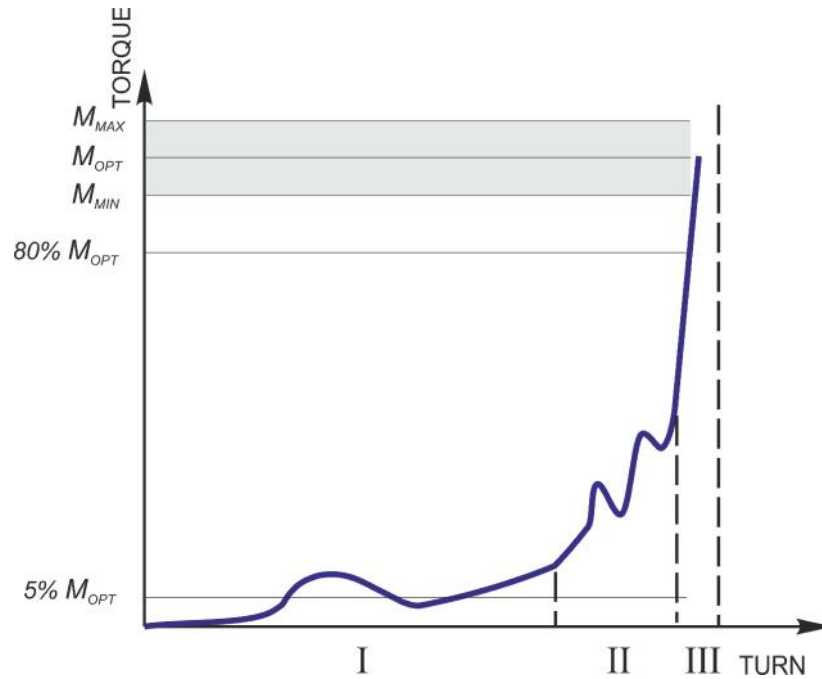

Figure 16 – Make-up diagram. Torque leaps

6.4.1.11 Make-up curve without clean shoulder torque sh (Figure 17) may result from:

- thread damage;
- improper thread cleaning;
- unfavorable combination of technological parameters of the connection.

Break out the connection, clean off the compound and inspect it. If the visual inspection is satisfactory, reapply thread compound of the appropriate type and quality and make-up the connection again.

If the shape of the make-up diagram after re-make-up is not changed, the pipe shall be laid aside and make-up with another pipe shall be performed. The laid aside pipe is allowed to be used for further make-up if no damages of surface or changes of thread shape, thread seals and thread shoulders are observed.

If the shape of the make-up diagram, when being made-up with another pipe, is not changed, the connection shall be broken-out and the previous pipe shall be replaced.

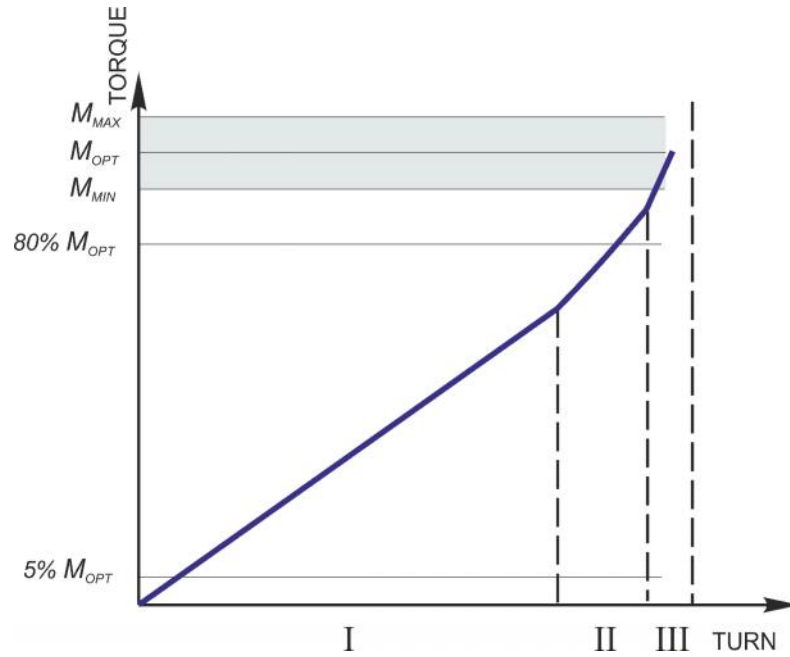

Figure 17 – Make-up diagram. No clear shoulder torque of thread shoulders

6.4.1.12 Make-up curve with a wave-like effect not exceeding shoulder torque ^{sh} (Figure 18) may result from:

- improper thread cleaning;
- thread compound contamination or high density of thread compound (e.g. at low temperatures);
- excess of compound.

Break out the connection, make sure the wave-like effect is not caused by the quality or application of the compound, and repeat make-up. Otherwise clean the connection, reapply thread compound of the appropriate type and quality, and repeat make-up.

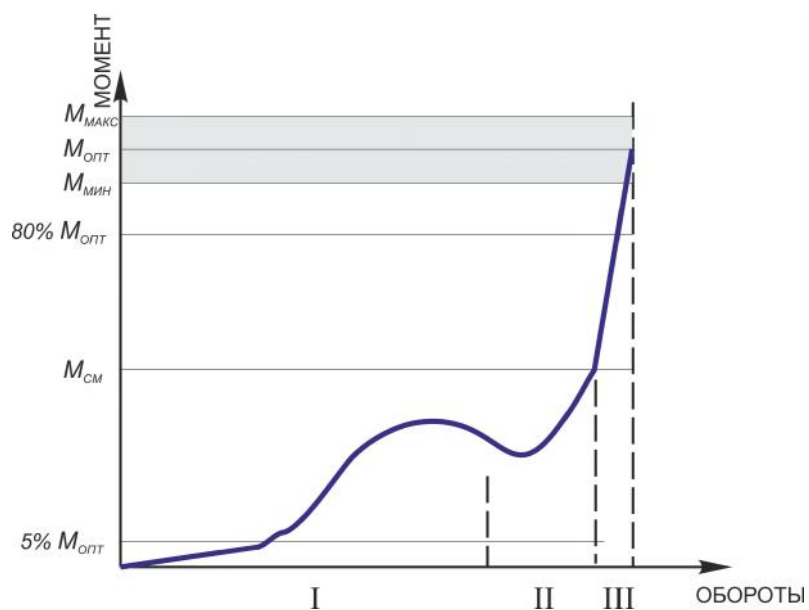

Figure 18 – Make-up diagram. Wave-like effect

6.4.1.13 Any time the make-up curve on the diagram is of improper shape, break out the connection. Remove compound from the surface of pin and coupling thread connections and inspect it. If during visual inspection damages or damages that can be repaired were not found (Table 2), reapply thread compound of the appropriate type and quality onto the connection, check the equipment setting and repeat make-up. If the result of make-up is the same as the first time, the pin and coupling shall be rejected.

6.4.2 Make-up inspection by make-up marks

6.4.2.1 When making-up thread connection by make-up marks, superimposition of the mark on the coupling with the first mark on pin in the direction of make-up, will correspond to shoulder of pin and box shoulders.

6.4.2.2 When make-up torque value is reached a make-up mark on the coupling shall coincide with the second mark on pin in the direction of make-up or be positioned between the first and the second marks that corresponds to rotation on shoulder of thread connection intended to reach given diametrical interferences in thread and radial seal as well as to engage thread shoulders in seal process (Figure 19).

Rotation on shoulder is accompanied by significant torque increase; herewith it shall be minimum 90 % and maximum 110 % of optimum make-up torque value.

6.4.2.3 When make-up torque value is reached, coupling end-face shall align with the base of make-up triangle (transverse stripe) on the pin with allowable deviation ± 0.0197 inch.

6.4.2.4 Various locations of make-up marks after thread connection make-up with optimum torque and corresponding to such make-up mating of thread shoulder surfaces is possible (Figure19).

Figure 19,) – the connection is under-torqued. The mark on coupling does not run up to the first mark on pin in the direction of make-up. It means that there is a gap between the mating surfaces of pin and coupling. Make-up is allowed to be continued till the mark on coupling aligns with the first or the second mark on pin in the direction of make-up [Figure 19 b), c), d)]. The make-up torque should not exceed its maximum value.

If the make-up torque exceeds its maximum value, and the mark on coupling doesn't reach the first mark on the pin in direction of make-up, the connection shall be broken-out, cleaned from compound, surfaces of pin and coupling connections shall be visually inspected.

If any unreparable damages are detected (Table 2), the connection shall be rejected.

If no visible damages are observed on the thread connection or the damages can be repaired (Table 2), upon elimination of damages the connection can be made-up again, herewith total number of make-ups shall be not more than three times.

When performing remake-up, the mark on coupling shall stay between the first and the second marks on pin or it may align with the second mark on pin [Figure 19 c), d)]. The torque shall be within the range from optimum to the maximum value.

When make-up is complete, inspection of make-up correctness shall be performed according to the position of make-up triangle.

Figure 19, b), c), d) – the connection is correctly made-up with the minimum rotation on shoulder [Figure 19 b)], with optimum rotation on shoulder [Figure 19, c)], with the maximum rotation on shoulder [Figure 19, d)].

Inspection of make-up correctness shall be performed according to the position of make-up triangle.

Figure 19, e) – the connection is over-torqued. The mark on coupling is located behind the second mark on the pin, that means possible deformation of mating pin and coupling seal surfaces.

In this case the coupling location shall be inspected relative to make-up triangle.

If the coupling end-face aligns with the make-up triangle base and the mark on coupling is located behind the second mark on pin at the distance of not more than 0.4724 inch [Figure 19, e)], the connection can be accepted.

If the coupling end-face aligns with the make-up triangle base, but the mark on coupling is located behind the second mark on pin at the distance of more than 0.4724 inch [Figure 19, e)], the connection shall be broken-out and inspected. The thread connection shall be rejected if deformation of pin and coupling seal surfaces is observed and shall be remade-up with optimum torque if no deformation is observed.

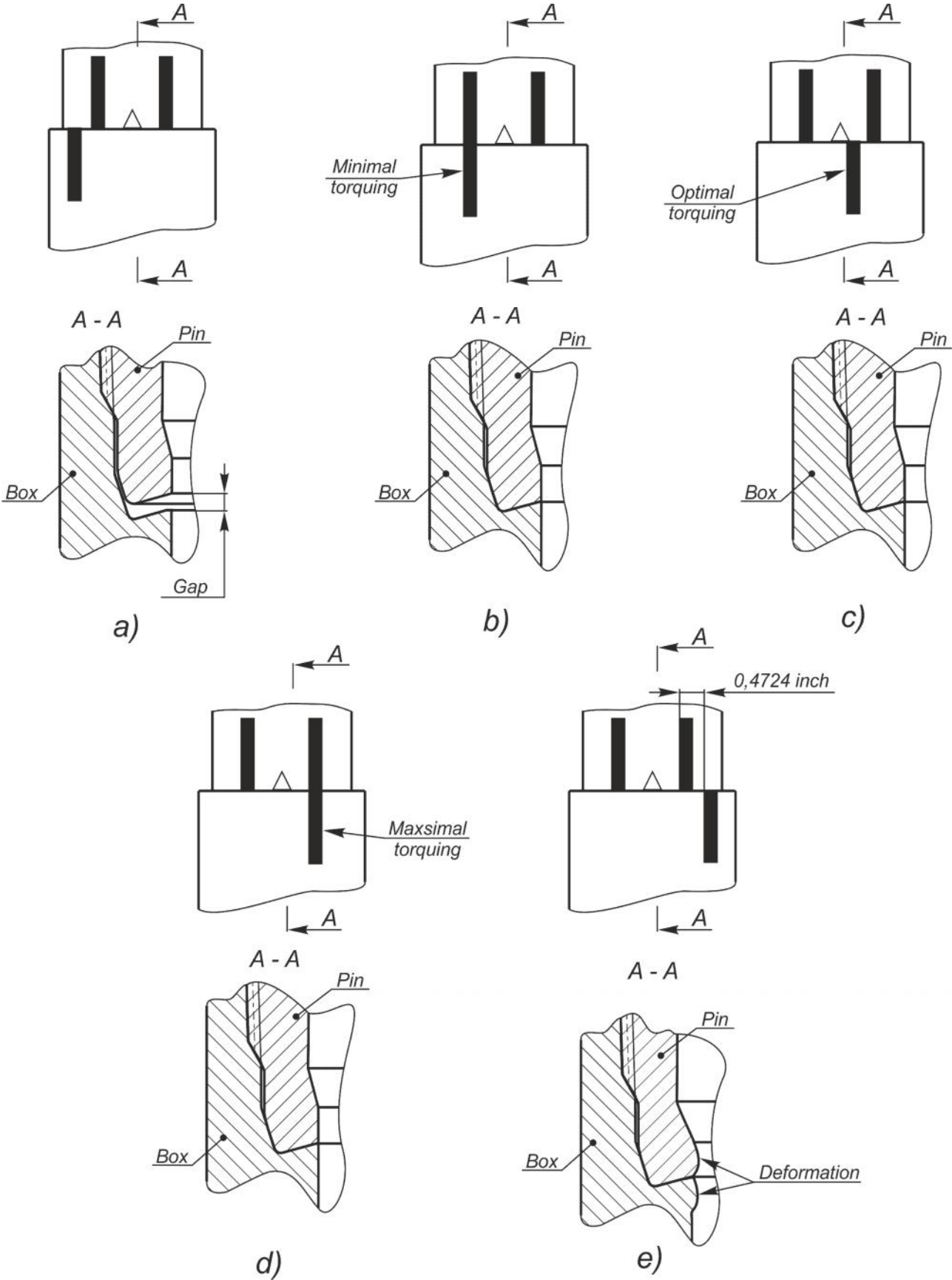

Figure 19 – Locations of make-up marks and mating surfaces of thread shoulders

6.5 Break-out of string

6.5.1 When the string is being pulled out of the well, pin end-faces are not allowed to hit against coupling end-faces.

6.5.2 Even longitudinal movement of the pipe resulted from gradual increase of number of engaged turns, shall be watched when the connection is broken-out.

Prior to break-out, the rotary tongs shall be positioned as per Figure 6.

6.5.4 Break-out torque shall provide for the connection disassembly.

6.5.5 Speed of connection break-out by rotary tong shall correspond to the ones, specified in Table 7.

Table 7 – Speed of thread connection break-out

Start of break-out		End of break-out
First two turns	Further turns	
Speed maximum 2 rpm,	Speed maximum 10 rpm	Speed maximum 2 rpm

6.5.6 Break-out shall not cause significant mechanical damages like galling, jamming or other imperfections on pipe and coupling body.

The outer surface of coupling shall be free of damages with the depth larger than 0.5% from the coupling nominal outside diameter.

Damages from tong clamps are allowed on the pipe outer surface under condition that the actual pipe wall thickness taking into account depth of the damage shall be not less than 87,5% from the nominal pipe wall thickness.

After make-up of chromium steel pipes the trace depth on the pipe body shall be not more than 0.0079 inch.

6.5.7 When the string is disassembled immediately after break-out thread protective elements shall be installed on pin and coupling ends.

6.5.8 To store used pipes after string disassembly, if necessary, following preparations shall be carried out:

- visual inspection of thread protectors for damages (ref. para. 5.2);
- visual inspection of pipes and couplings for significant mechanical damages (like galling, jamming etc.) (ref. para. 5.2);
- cleaning of pin and couplings thread connections from compound and contaminations (ref. para. 5.4);

– visual inspection of thread, thread seals and thread shoulders surfaces of pins and coupling (ref. para.5.5). In case of any damages detection, repair as per Table 1 or reject the pipes and couplings;

– cleaning of thread protectors from previously applied compound and contaminations (ref. para. 5.8);

– application of preservation compound (like «Kendex OCTG» or equivalent) or preservation thread compound on pin and coupling thread connections and installation of thread protectors.

7 Manufacturer's warranty

Provided that the present recommendations are met, UP F ET thread connection shall withstand at least 3 make-up and break-out cycles preserving the same technical characteristics.

Annex (mandatory)

Equipment for make-up registration

UP F ET thread connection shall be made-up using equipment for make-up registration and saving of make-up diagram (make-up curve) in a graphical or electronic format.

The curve is plotted based on torque values along vertical axis and number of turns along horizontal axis which shall have a linear scale. Only two last revolutions shall be displayed as torque increases at the end of make-up.

When using a computer make-up diagram shall have the following characteristics:

- Sufficient resolution (at least 800 × 600 pixels) for precise curve display. Display shall be at least 0.9843 inch in diagonal, herewith make-up curve shall take at least 80 % of display;
- Display of minimum and maximum torque with horizontal lines (if required, optimum torque shall be displayed);
- Display of minimum and maximum shoulder torque of thread shoulders with horizontal lines;
- Automatic and manual determination of shoulder torque of thread shoulders;
- Display of rig floor number of each make-up;
- Display of date and time of each make-up;
- Availability of comments;
- Display of company-customer name, well number, pipe diameter, weight, steel grade, type of thread connection, thread compound data and pipe manufacturer;
- When applicable, superimposing of latest make-up curve over the curves of previous satisfactory make-up diagrams;
- When applicable, display of make-up speed in rpm, either on the make-up curve or on a separate graph.

Displayed make-up results shall not be sufficient for acceptance or rejection of make-up operations. Correctness of make-up shall be confirmed by a competent specialist.

**Prior to running the casing downhole
the calibration certificate with the latest and next planned equipment
calibration dates shall be checked!**